

iQ-PH LED POWER SUPPLY 80W



The iQ-PH is an ideal constant voltage electronic dimmable power supply for interior or exterior linear LED applications. It is capable of providing full-range 0-100% flicker-free dimming using either forward or reverse phase dimmers. Available in 80W at 24VDC and is UL Listed and Class II rated. Available finishes are satin/white and all black.



Part Number Builder

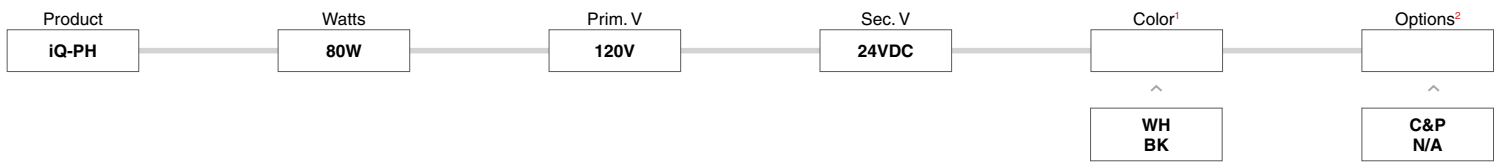

Technical Information

NOTE: The LED drivers provide a constant voltage output for operating LED systems requiring 24VDC

MODEL #	CHANNEL OUTPUT	OUTPUT				MAX OUTPUT POWER PER CHANNEL (W)	RATED OUTPUT POWER	
		VOUT (VDC)	Loading Current (w/dimmer) per channel (A)		Loading Current (w/out) per channel (A)			
			MIN	MAX	MIN		MAX	MAX
iQ-PH-80-120/24	1	24	1.16	3.30	0.17	3.30	79.2	80

¹ Color

WH White
BK Black

² Options

C&P Cord & Plug

Voltage Drop Chart

VDC	Watts (W)	10 AWG (5.6mm ²)	12 AWG (3.3mm ²)	14 AWG (3.0mm ²)	16 AWG (1.3mm ²)	18 AWG (0.78mm ²)	20 AWG (0.50mm ²)	22 AWG (0.33mm ²)	24 AWG (0.22mm ²)	26 AWG (0.13mm ²)
24	17	940'	591'	372'	234'	147'	92'	58'	37'	23'
	25	629'	396'	249'	157'	98'	62'	39'	24'	15'
	40	384'	242'	152'	96'	60'	38'	24'	15'	9'
	80	180'	113'	71'	45'	28'	18'	11'	7'	4'

*Distances are based on a 5% Voltage drop max.

• This product must be installed in accordance with the applicable installation code by a person familiar with the construction and operation of the product and the hazards involved



FRONT VIEW

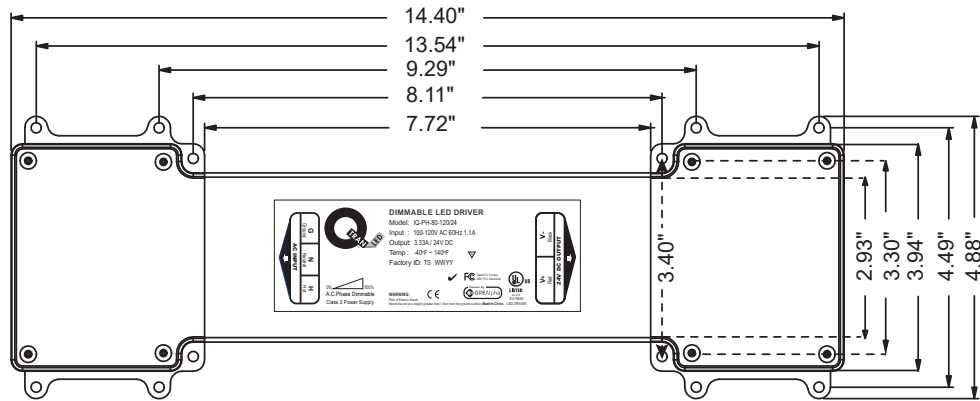

SIDE VIEW

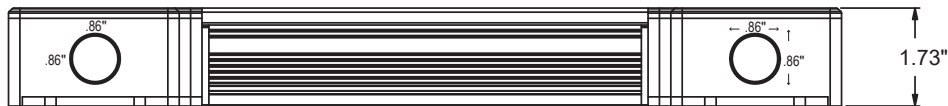

TOP VIEW

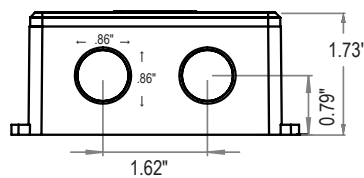

BOTTOM VIEW

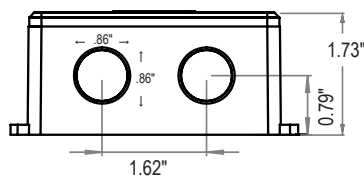

- Wide dimmer compatibility-supports most phase type dimmers in the market
- Forward phase and reverse phase dimmer control or on/off
- Integral wiring compartments for reduced installation costs
- Completely potted design, no venting required
- Energy Star Compliant
- Active Power Factor Correction, PF>0.9
- Operating temperature range: -40 to +60°C (-40 to +140°F)
- Constant voltage



Specifications

Input	Min	Nom	Max
Voltage (RMS)	220	230	240
Frequency (Hz)	47	50/60	63
Power Factor	0.9	---	---

Output	Min	Nom	Max
Line Regulation (%)	-10	---	10
Load Regulation (%)	---	---	5

Environmental	Min	Nom	Max
Storage Temperature (°C)	-40	---	85
Operating Temperature	-40	---	60
Relative Humidity (%)	5	---	95
MTBF (Hours @ 25°C (77°F), Full Load)	80,000	---	---

Expected Lifetime	Temp
50,000 hours	65°C
30,000 hours	75°C

Protections

- Short Circuit Protection (SCP)
- Over Voltage Protection (OVP)
- Over Current Protection (OCP)
- Over Temperature Protection (OTP)
- Hiccup-Mode, Auto-Recovery upon removal of short
- 105% of Voltage (typ) Min

Compliance/Safety

- EMI/RFI : ISPR-22 Class B
: FCC part 15 Class B
: EN55015, EMC
- Safety : UL 1012, 1310 Class 2, 8750, 879
: CSA C22.2 NO. 107.1
: CE (IEC/EN61347-1, IEC/EN61347-2-13)

Dimming Options

- Supported Dimming : 230VA Rated ELV (Reverse Phase) & Triac (Forward Phase Dimming)

DERATING CURVE

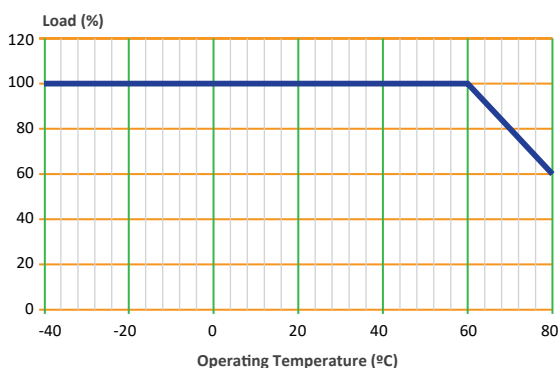

OUTPUT VOLTAGE vs. LOAD

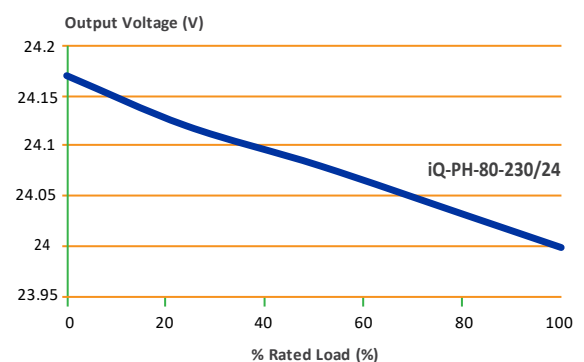

Supported Dimming List 90~120V AC ELV (Reverse phase) & Triac (Forward phase) Dimmer

Brand	Model	Dimmer Rating Power (max)	LED Flicker Free Test*
Lutron	DVCL-153PL (C/L)	600W	Pass
Lutron	TGCL-153P (C/L)	600W	Pass
Lutron	AB-600M-WH (Abella)	600W	Pass (##)
Lutron	D-600RH-DK (Rotary)	600W	Pass
Lutron	D-600R-WH (Rotary)	600W	Pass
Lutron	D-603PG-WH (Rotary)	600W	Pass
Lutron	GL-603PH-DK (GLYDER-3-way)	600W	Pass
Lutron	GL-600-WH (Glyder)	600W	Pass (##)
Lutron	MA-600GH-WH (Ecodim Digital with indicator leds)	500W	Pass (##)
Lutron	MIR-600THW-WH (RC Digital Fade Dimmer)	600W	Pass
Lutron	MS-VP600GHW-WH (Vacancy Sensor w/eco-dim Dimmer)	600W	Pass (##)
Lutron	S-600PH-WH (SKYLARK))	600W	Pass
Lutron	SELV-300PH-WH (SKYLARK-Single Pole)	300W	Pass
Lutron	TG-600PH-WH (Toggler)	600W	Pass
Lutron	TG-603PFH-WH (Toggler-eco-dim)	600W	Pass
Lutron	TT-300NLH-BL	600W	Pass
Cooper Wiring Devices	RI061-A (Rotary Dimmer w/ Non-Present)	600W	Pass
Cooper Wiring Devices	6001	600W	Pass
Cooper Wiring Devices	SLC03P (C/L)	600W	Pass
Cooper Wiring Devices	SI06P (non C/L)	600W	Pass
GE	DI61-271	600W	Pass
GE	DIB61-71	600W	Pass
GE	DIT61-71	600W	Pass
GE	DIT61-S71	600W	Pass
Legrand	V8051	600W	Pass

NOTE: ● ## -5-100% dimming range.

- Flicker tests were carried out to ensure full range, flicker-freedimming from min to full load.
- This is a representative list of dimmers only. Q-Tran makes nospecific recommendation on product selection and there are no warranties of performance or compatibilityimplied. Refer to dimmer manufacturers for further information on LED compatibility. Lutron and their productbrand names are registered brand names are registered trademarks.

