

QTM-eLED(L) LED POWER SUPPLY 40W-200W



The QTM-eLED(L) can house up to five 40W Lutron hi-lume constant voltage or constant current drivers. Each driver can be independently controlled or wired together. The drivers are capable of 100% - 0.1% dimming, soft-on, soft-off, and can be fully loaded. The power supplies and modules are all prewired together along with terminal blocks for power and control wires. The housing can be recessed or surface mounted.



Part Number Builder

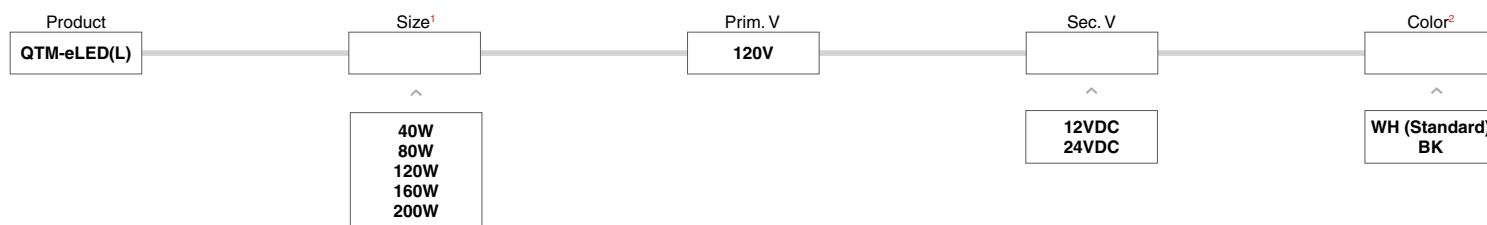

Technical Information

¹ Size

Size	Max Load (Watts)	Secondary Voltage (12/24VDC)	Max Prim Amps @ 120V
40W	1x40W	12VDC/24VDC	0.41A
80W	2x40W	12VDC/24VDC	0.82A
120W	3x40W	12VDC/24VDC	1.23A
160W	4x40W	12VDC/24VDC	1.64A
200W	5x40W	12VDC/24VDC	2.05A

² Color

WH White (Standard)
BK Black Powder Coat Finish

Voltage Drop Chart

VDC	Watts (W)	10 AWG (5.6mm ²)	12 AWG (3.3mm ²)	14 AWG (3.0mm ²)	16 AWG (1.3mm ²)	18 AWG (0.78mm ²)	20 AWG (0.50mm ²)	22 AWG (0.33mm ²)	24 AWG (0.22mm ²)	26 AWG (0.13mm ²)
12	12	315'	198'	125'	78'	49'	31'	19'	12'	7'
	25	115'	72'	45'	28'	18'	11'	7'	4'	3'
	40	58'	36'	22'	9'	5'	3'			
24	25	567'	356'	224'	141'	88'	56'	35'	22'	14'
	40	309'	194'	122'	77'	48'	30'	30'	12'	7'

*Distances are based on a 5% Voltage drop max.

• This product must be installed in accordance with the applicable installation code by a person familiar with the construction and operation of the product and the hazards involved



QTM-eLED(L)

LED POWER SUPPLY 40W-200W

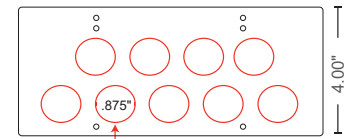
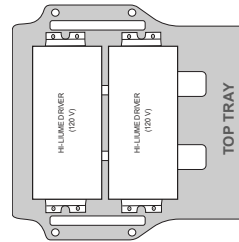
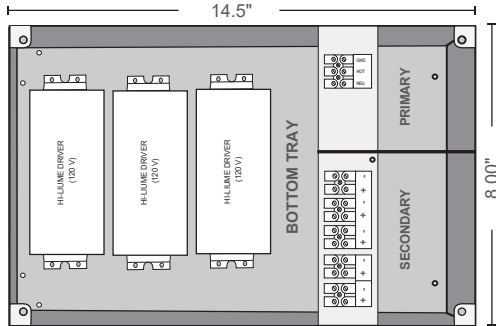

9 Knockouts of 0.875" Hole for 1/2" fitting

NOTE: 16 additional side knockouts

Housing

- 18 gauge welded steel enclosure: 14.5"W x 8.00"H x 4.00"D
- Door: 15.5"W x 9.00"H
- Knockouts: 25
- Built-in support bracket incorporated to secure housing for surface mounting

Performance

- Power Supply
 - : Rated for surface mount or recessed use
 - : Fully rated to operate low voltage load at listed wattage (No derating required)
 - : Voltage regulation to 5% or less of rated output voltage
 - : Primary voltage of 120V
- Low Voltage Lighting Systems
 - : CSA Class 3425-15 and Class 3425-95
 - : Short circuit protection (SCP)
 - : Overload protection (OLP)
 - : Live tested by the manufacture to ensure proper operation
 - : Manufacturer offers a minimum of 5 years warranty
- Terminal blocks is made of tin plated copper with a voltage rating of 300V and a current rating of 40A

- Limited output voltage and current, plus isolation for safe operation
- Fully potted driver(s) for moisture resistance
- Suitable for dry and damp locations
- Suitable for surface or recessed mounting use
- Primary voltage - universal (120-277V)
- Phase dimmed
- Wide operating temperature range: 32°F to 149°F

- Fits up to 5 of the 40W drivers in the same housing
- 5 years warranty
- Class 2 output
- CSA #239924

Low Voltage Lighting Systems

- : CSA class 3425-15 and class 3425-95
- : CSA standard C22.2 No. 250.0-08 - Luminaires
- : ANSI/ UL standard 2108 - Low voltage lighting systems
- : CSA standard C22.2 No 250.13-14 - Light emitting diode (LED) equipment for lighting applications
- : ANSI/ UL standard 8750 - Light emitting diode (LED) equipment for use in lighting products



QTM-eLED(L) LED POWER SUPPLY 40W-200W



Specifications

Input	12VDC	24VDC
Input Voltage (Vrms)	120	120
Input Current, max (Arms)	0.41	0.37
Inrush Current, max* (Apk)	2	2
Input Frequency (Hz)	50/60	50/60
Input Power (W)	70	117

Output	12VDC	24VDC
Output Voltage, nom (V)	12	24
Output Current (A)	3.3	1.7
Output Power (Wmax)	40	40
Efficiency	70%	84%

Environmental	Min	Nom	Max	Min	Nom	Max
THD (%)	---	---	20	---	---	20
PF (%)	0.90	---	---	0.90	---	---
Case Temp (°C)	---	---	90	---	---	90

*- 200us event

Protections

- Short Circuit Protection (SCP)
- Overload Protection (OLP)
- Class 2 Output

Compliance

- EMI Spec : FCC 47 Part 15
: CISPR 15
: CISPR 22 Class A
- CSA Certified : UL-2108
: UL-8750
: CSA C22.2 No 250.0-08
: CSA C22.2 No 250.13-14

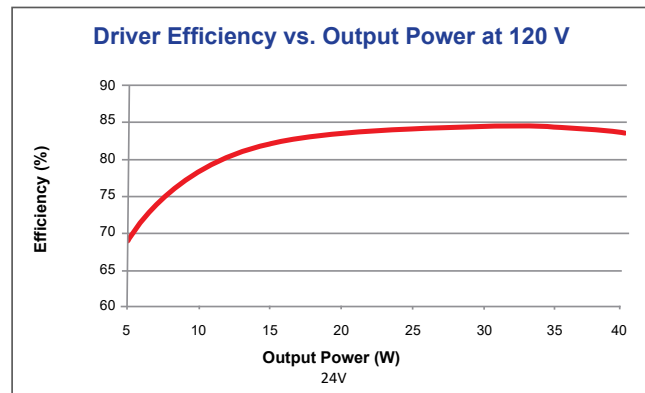
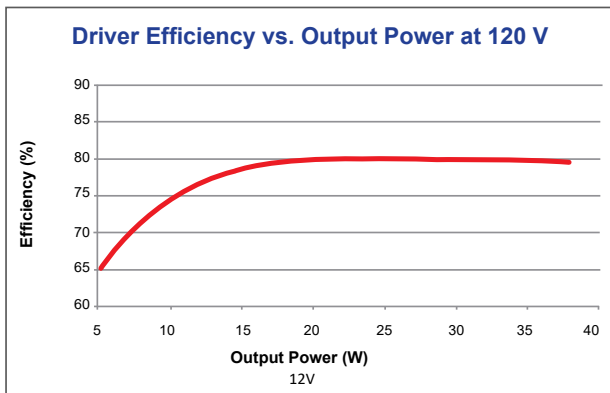
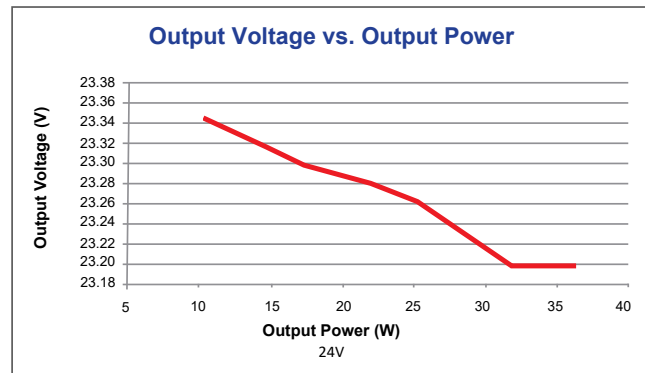
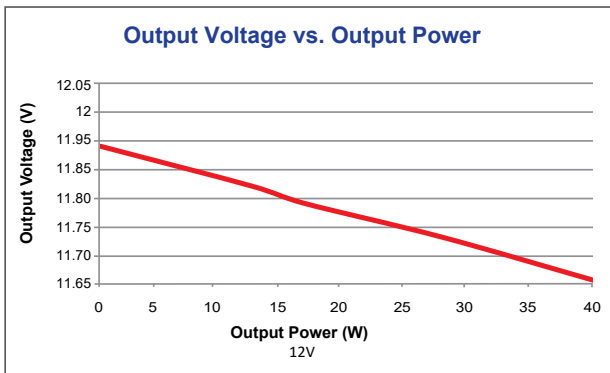

QTM-eLED(L) LED POWER SUPPLY 40W-200W



Wiring Diagram

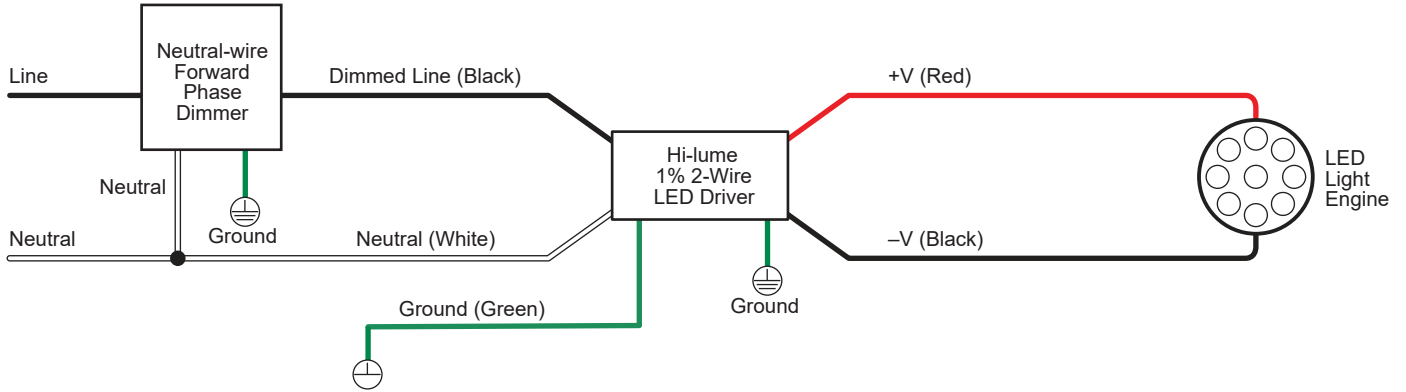

INSTALLATION

LED POWER SUPPLY - QTM-eLED(L)



Housing

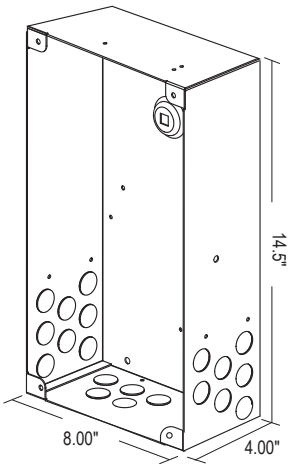

ISOMETRIC VIEW

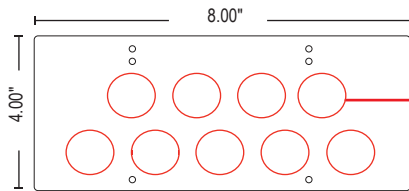

BOTTOM VIEW

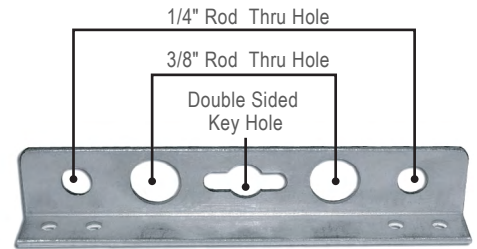

NOTE: Bracket can also be mounted (Top & Bottom) for Vertical Mounts.

Mounting Options

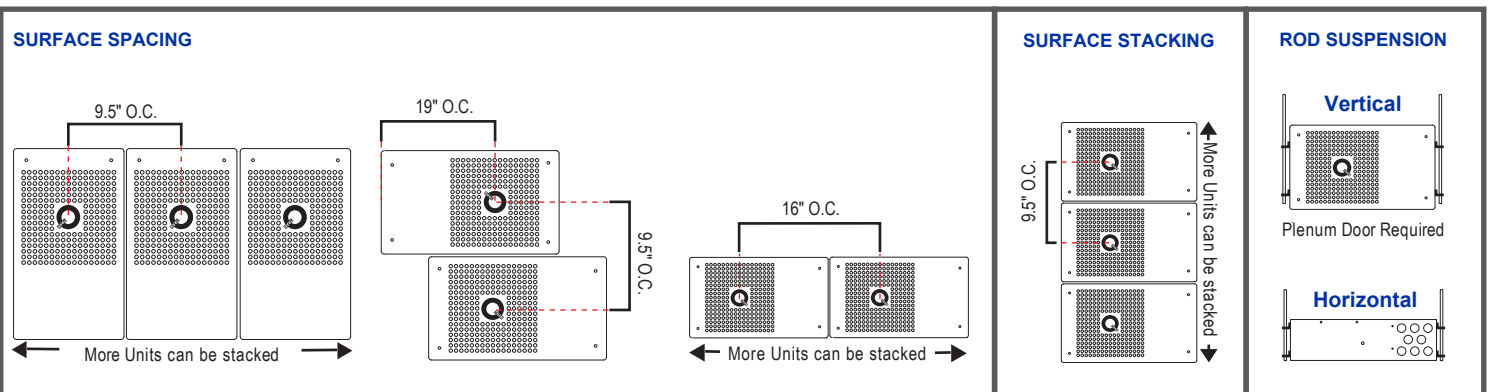
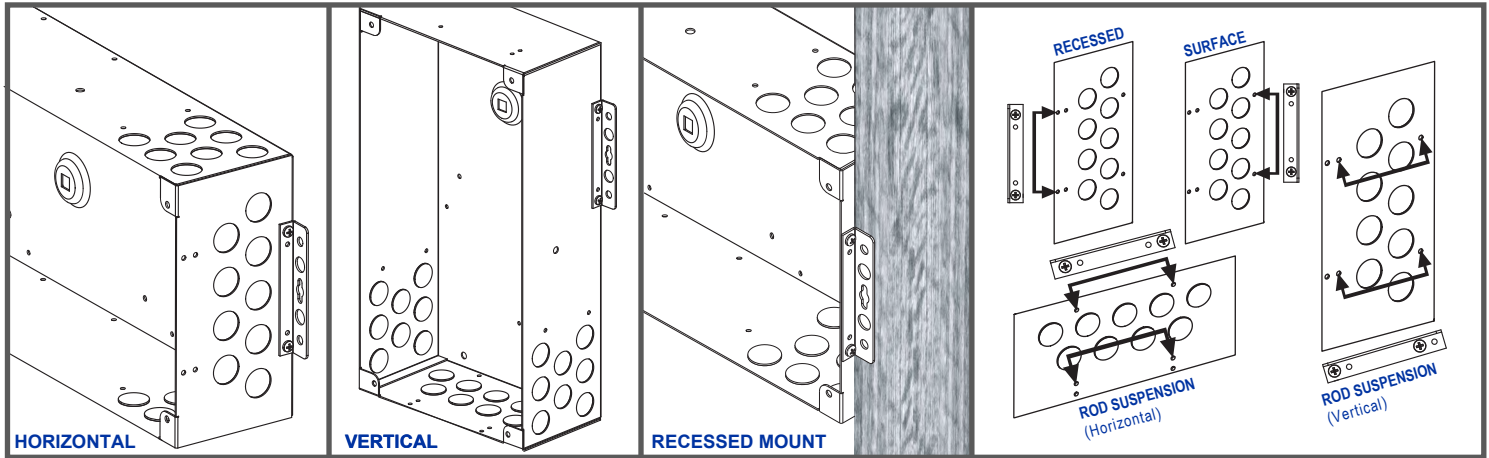

NOTE: Rods not included.

INSTALLATION

LED POWER SUPPLY - QTM-eLED(L)



Wiring Diagram

