

Photometric Details

SC24-5.0_DRY_R



Product name: SC24-5.0_DRY_R	
Date: 6/4/2018	
Powering product: IQ-PH-80-120/24	
<hr/>	
Output:	104 lm/ft
Peak:	28.9 cd
Power:	5.2 W/ft
PF:	1.0



Light efficiency:



Light quality:



Color temperature:



Beam Angle

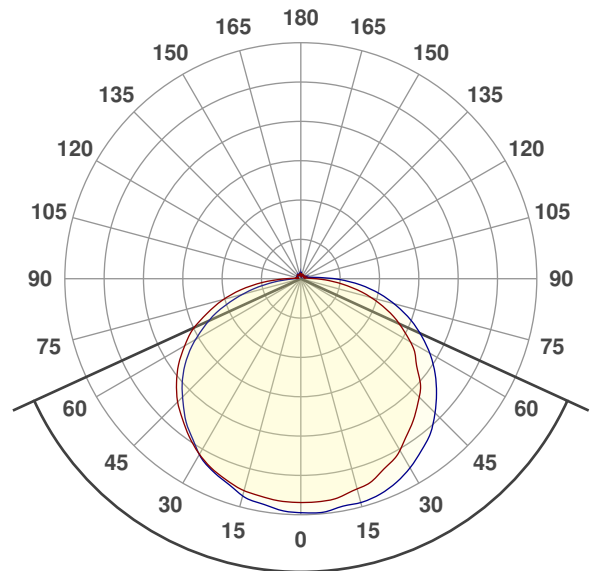

130.8°



CIE 1931
x: 0.684
y: 0.295

Spectra

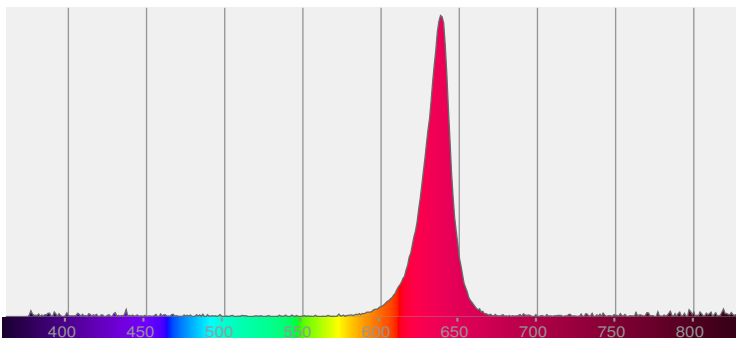

Power

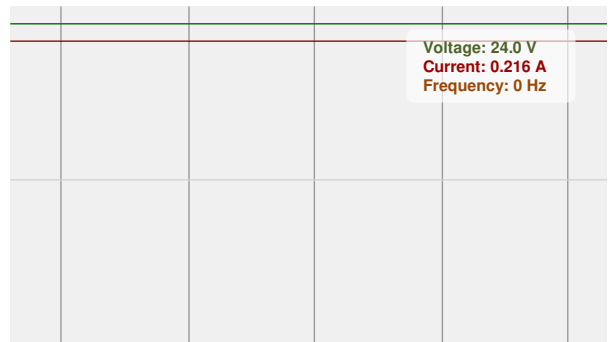

Voltage: 24.0 V
Current: 0.216 A
Frequency: 0 Hz

Color Details

SC24-5.0_DRY_R

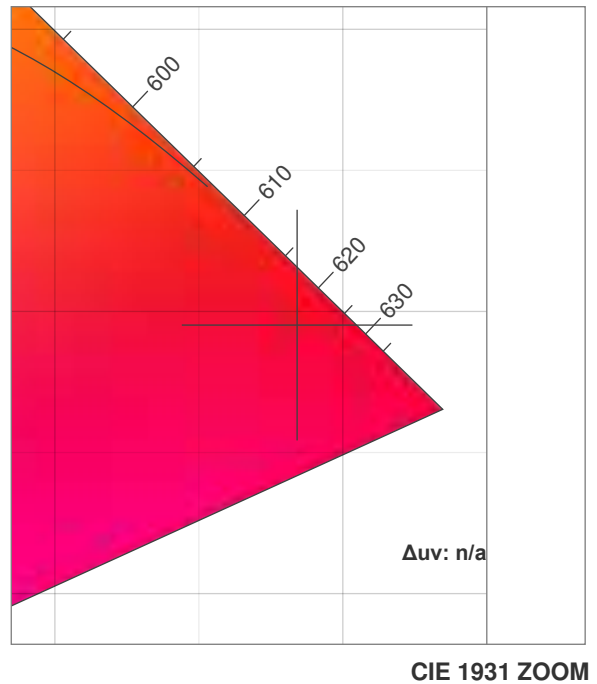
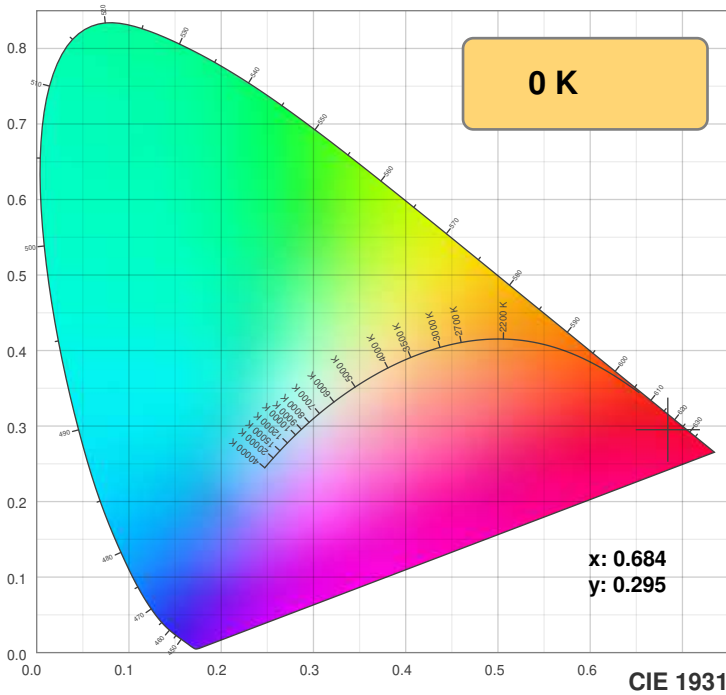

TM30: 0.0

CRI: 0.0 (R1-R8)

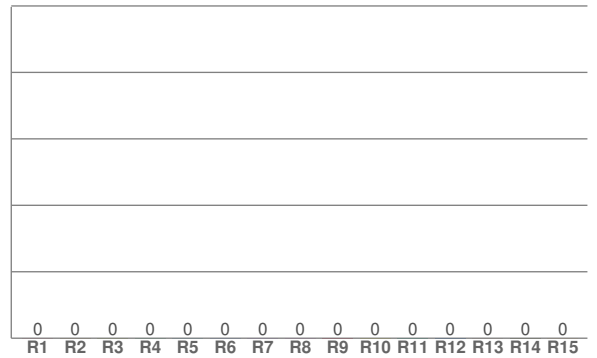
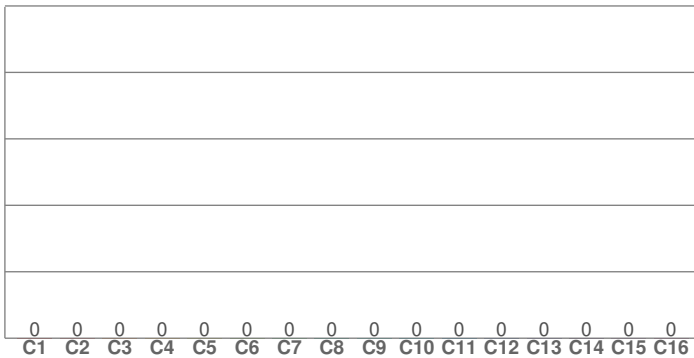

CRI R values, only R1-R8 are used to calculate final CRI value

R1	R2	R3	R4	R5	R6	R7	R8	R9	R10	R11	R12	R13	R14	R15
0.0	0.0	0.0	0.0	0.0	0.0	0.0	0.0	0.0	0.0	0.0	0.0	0.0	0.0	0.0

TM30 C values, 16 binned values out of total of 99 C values

C1	C2	C3	C4	C5	C6	C7	C8	C9	C10	C11	C12	C13	C14	C15	C16
0.0	0.0	0.0	0.0	0.0	0.0	0.0	0.0	0.0	0.0	0.0	0.0	0.0	0.0	0.0	0.0

CQS Q values

Q1	Q2	Q3	Q4	Q5	Q6	Q7	Q8	Q9	Q10	Q11	Q12	Q13	Q14	Q15
0.0	0.0	0.0	0.0	0.0	0.0	0.0	0.0	0.0	0.0	0.0	0.0	0.0	0.0	0.0

CQS: 0.0

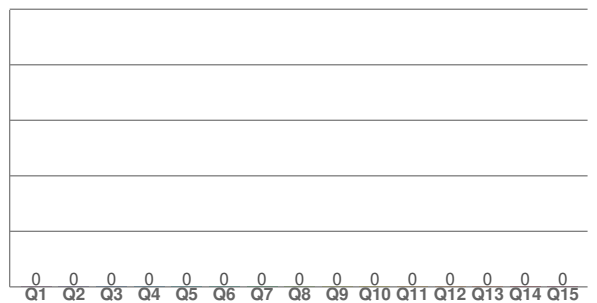

Color parameters

Color temperature	Color rendering index	Red component	Color fidelity	Color gamut	Color quality scale	Color coordinate cie 1931	Color coordinate cie 1931	Color coordinate	Color coordinate	Color deviation from black body
CCT	CRI	CRI R9	TM30 Rf	TM30 Rg	CQS	x	y	u	v	Δuv
0 K	0.0	0.0	0.0	0.0	0.0	0.684	0.295	0.529	0.342	n/a

TM30 Details

SC24-5.0_DRY_R



Rf 0.0
Fidelity index Rf

Rg 0.0
Gammut index Rg

Hue Bin	R _f	Graphic shifts (%)	
		Chroma	Hue
1	0	0%	0%
2	0	0%	0%
3	0	0%	0%
4	0	0%	0%
5	0	0%	0%
6	0	0%	0%
7	0	0%	0%
8	0	0%	0%
9	0	0%	0%
10	0	0%	0%
11	0	0%	0%
12	0	0%	0%
13	0	0%	0%
14	0	0%	0%
15	0	0%	0%
16	0	0%	0%

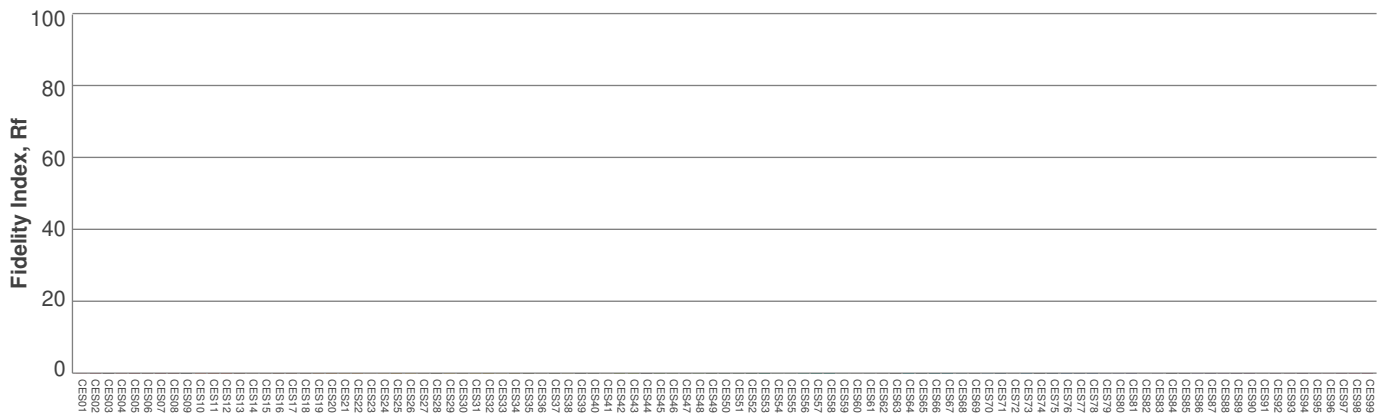
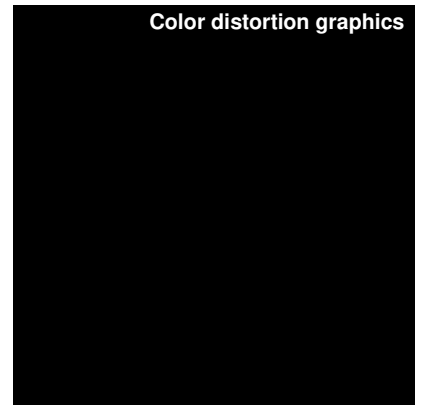
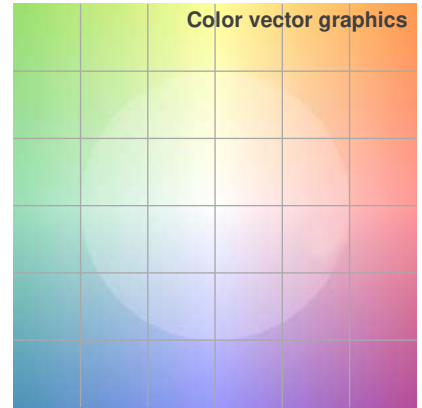
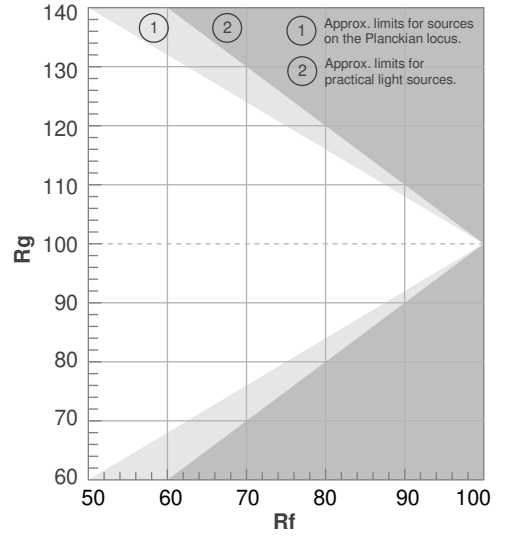

Color Evaluation Sample



Product name:
SC24-5.0_DRY_G

Date:
2/27/2018

Powering product:
IQ-PH-80-120/24

Output: **583 lm/ft**

Peak: **151 cd**

Power: **5.7 W/ft**

PF: **1.0**



Light efficiency:



Light quality:



Color temperature:



Beam Angle

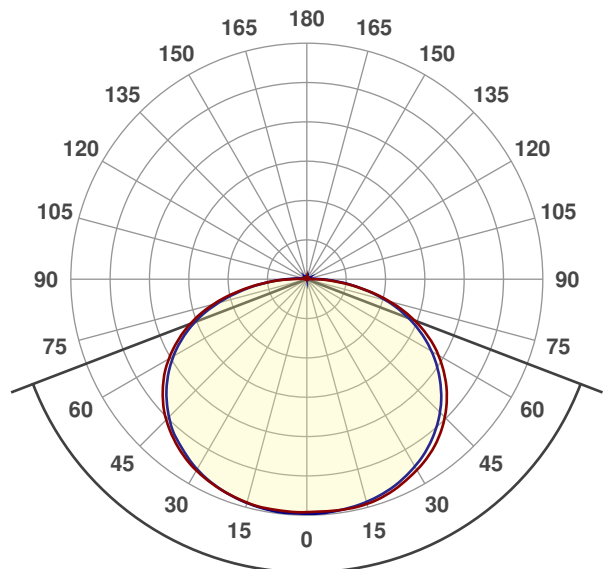

138.1°



CIE 1931
 x: 0.142
 y: 0.717

Spectra

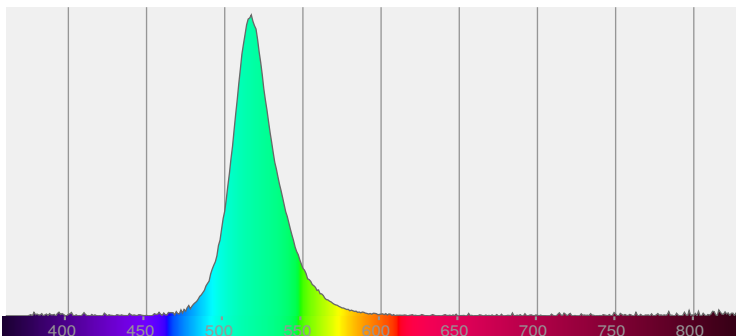

Power

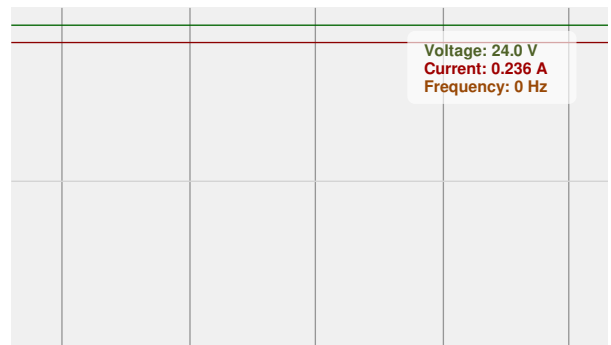



TM30 Details

SC24-5.0_DRY_G

Rf 0.0
Fidelity index Rf

Rg 0.0
Gammut index Rg

Hue Bin	R _f	Graphic shifts (%)	
		Chroma	Hue
1	0	0%	0%
2	0	0%	0%
3	0	0%	0%
4	0	0%	0%
5	0	0%	0%
6	0	0%	0%
7	0	0%	0%
8	0	0%	0%
9	0	0%	0%
10	0	0%	0%
11	0	0%	0%
12	0	0%	0%
13	0	0%	0%
14	0	0%	0%
15	0	0%	0%
16	0	0%	0%

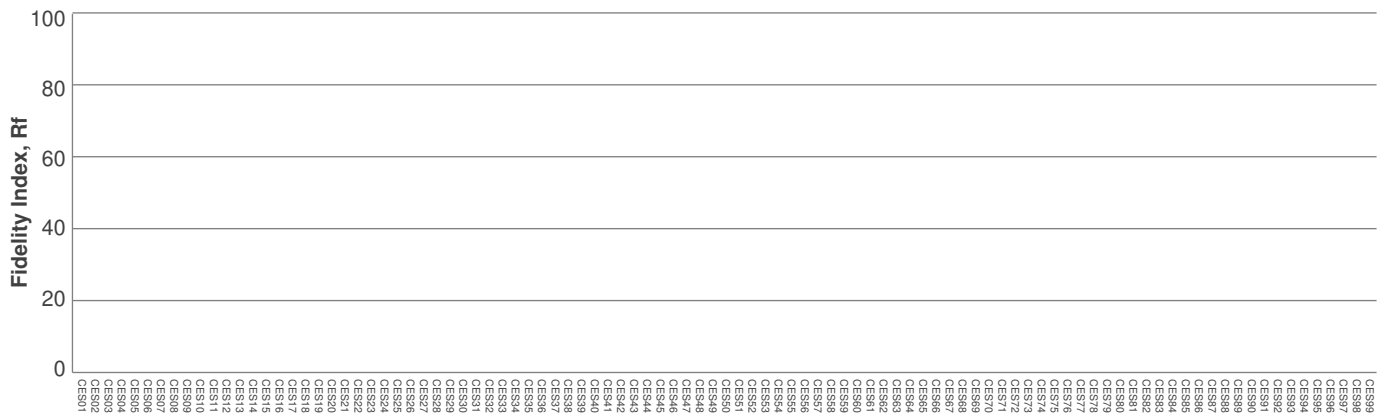
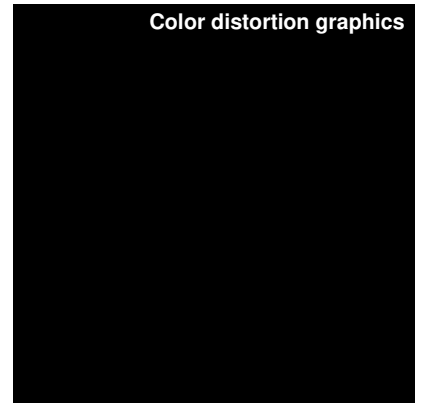
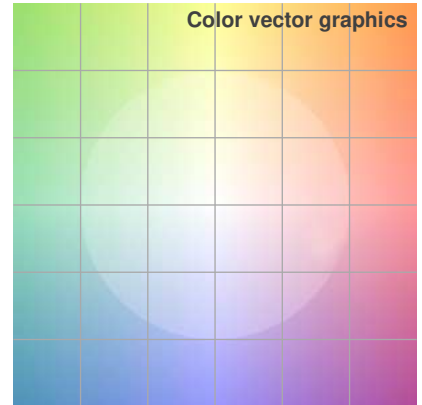
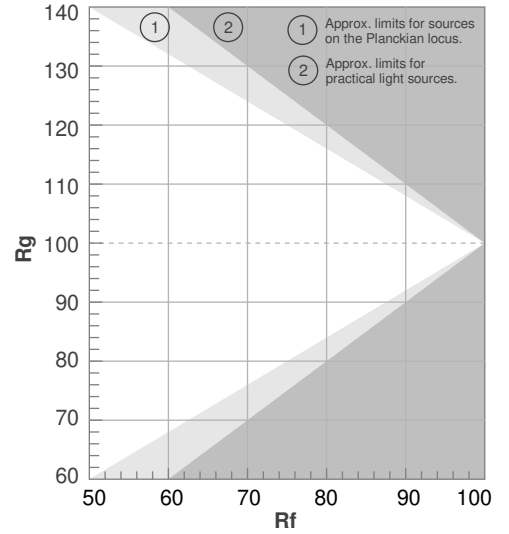

Color Evaluation Sample



Beam Details

SC24-5.0_DRY_G

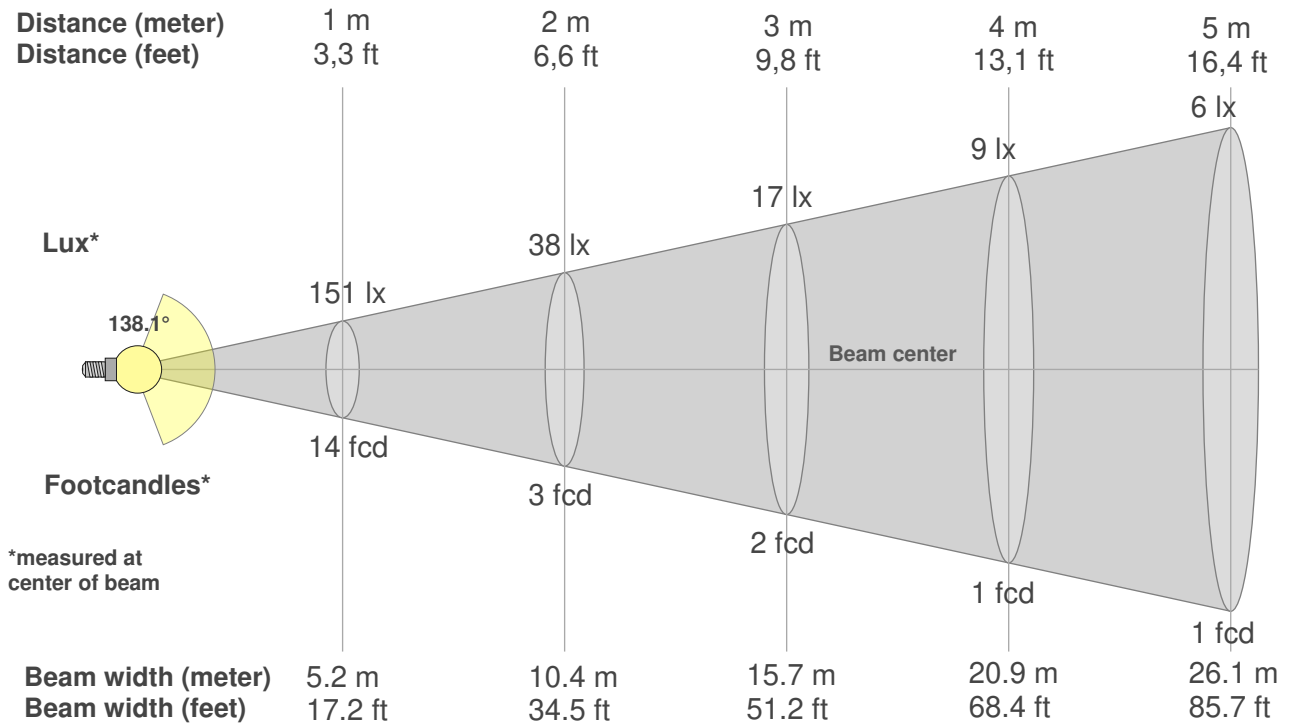

Beam intensities from 1-20m

1m	2m	3m	4m	5m	6m	7m	8m	9m	10m	11m	12m	13m	14m	15m	16m	17m	18m	19m	20m
3.3ft	6.6ft	9.8ft	13.1ft	16.4ft	19.7ft	23ft	26.2ft	29.5ft	32.8ft	36.1ft	39.4ft	42.7ft	45.9ft	49.2ft	52.5ft	55.8ft	59.1ft	62.3ft	65.6ft
151lx	38lx	17lx	9lx	6lx	4lx	3lx	2lx	2lx	2lx	1lx	1lx	1lx	1lx	1lx	1lx	1lx	0lx	0lx	0lx
14fcd	3.5fcd	1.6fcd	0.9fcd	0.6fcd	0.4fcd	0.3fcd	0.2fcd	0.2fcd	0.1fcd	0.1fcd	0.1fcd	0.1fcd	0.1fcd	0.1fcd	0.1fcd	0fcd	0fcd	0fcd	0fcd

Intensities in 0° c-plane

0°	5°	10°	15°	20°	25°	30°	35°	40°	45°	50°	55°	60°	65°	70°	75°	80°	85°	90°	95°
151	150	150	150	148	145	142	138	132	126	118	108	98	86	71	55	38	21	8	2
100%	100%	100%	99%	98%	96%	94%	91%	88%	83%	78%	72%	65%	57%	47%	37%	25%	14%	5%	1%

Intensities in 90° c-plane

0°	5°	10°	15°	20°	25°	30°	35°	40°	45°	50°	55°	60°	65°	70°	75°	80°	85°	90°	95°
151	151	150	149	146	143	139	134	128	121	113	103	93	81	68	53	37	22	10	3
100%	100%	100%	99%	97%	95%	92%	89%	85%	80%	75%	69%	62%	54%	45%	35%	25%	15%	7%	2%

Intensities in 180° c-plane

0°	5°	10°	15°	20°	25°	30°	35°	40°	45°	50°	55°	60°	65°	70°	75°	80°	85°	90°	95°
151	150	150	149	147	145	142	139	134	128	121	113	102	91	78	62	45	27	12	3
100%	100%	99%	99%	98%	96%	94%	92%	89%	85%	80%	75%	68%	60%	51%	41%	30%	18%	8%	2%

Intensities in 270° c-plane

0°	5°	10°	15°	20°	25°	30°	35°	40°	45°	50°	55°	60°	65°	70°	75°	80°	85°	90°	95°
151	151	151	149	147	145	141	137	132	126	118	109	99	88	74	59	43	27	14	6
100%	100%	100%	99%	98%	96%	94%	91%	88%	83%	78%	73%	66%	58%	49%	39%	28%	18%	9%	4%

Beam angle 50%	Field angle 10%	Cutoff angle 2,5%	Intensity ratio in 120° cone	Intensity ratio in 90° cone
138.1°	176.3°	188.5°	69.1%	44.1%

ISO candela diagram

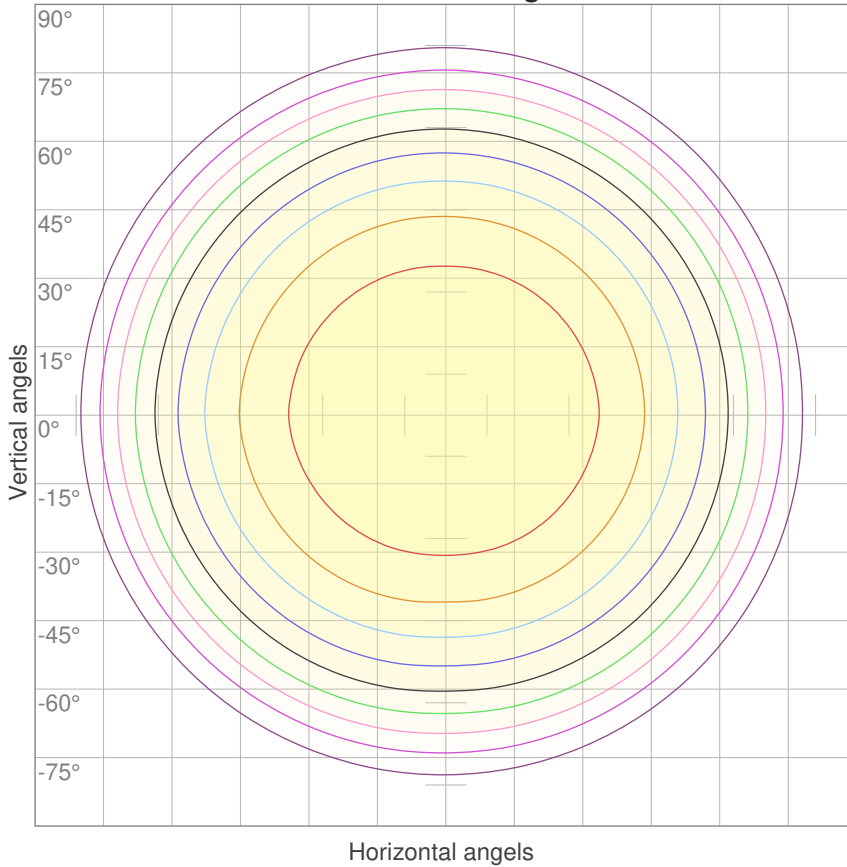

10%	15 cd
20%	30 cd
30%	45 cd
40%	60 cd
50%	75 cd
60%	90 cd
70%	105 cd
80%	121 cd
90%	136 cd

Conditions:

Number of c-planes: 4

Candela at center: 151 cd

ISO lux diagram

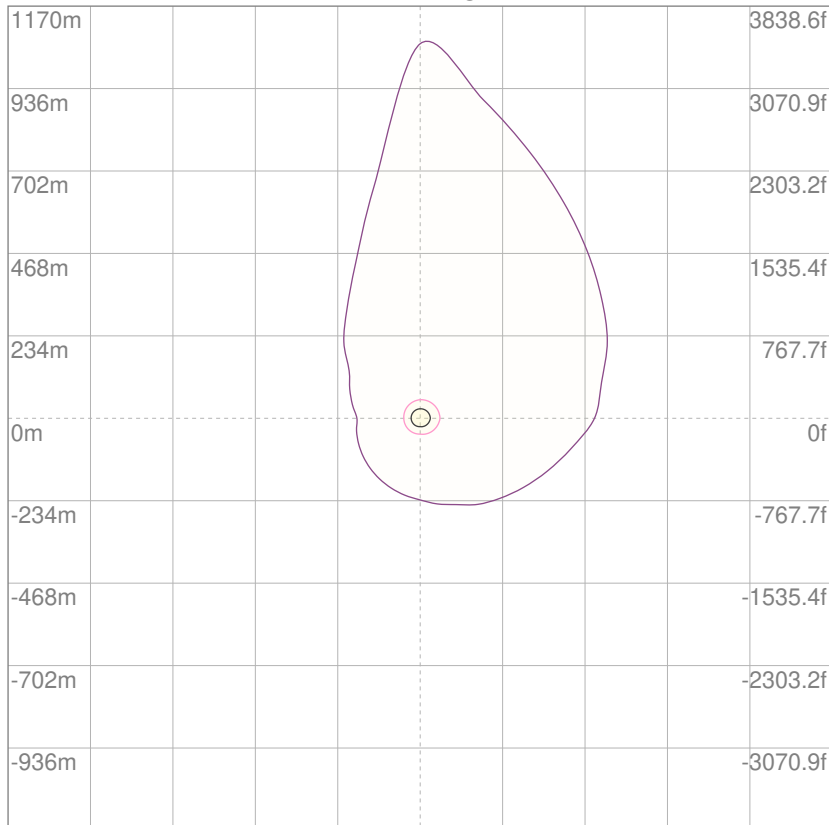

3%	45.2m lx
5%	75.3m lx
10%	0.151 lx
30%	0.452 lx
50%	0.753 lx

Conditions:

Number of c-planes: 4

Lux at center: 1.51 lx

Lux distribution on a surface when lamp is mounted at 10 meters from the surface.

Mounting height: 10 meters (33 feet)



Coefficients of Utilization

Ceiling reflectance	80				70				50			30			10			0
Wall reflectance	70	50	30	10	70	50	30	10	50	30	10	50	30	10	50	30	10	0
Floor reflectance	20	20	20	20	20	20	20	20	20	20	20	20	20	20	20	20	20	0
RCR	(RCR: Room Cavity Ratio)																	
	Room Values are expressed as percentage of Lumens delivered to the task surface																	
0	119	119	119	119	116	116	116	116	110	110	110	105	105	105	101	101	101	99
1	106	101	96	91	103	98	94	89	94	90	86	89	86	83	86	83	81	78
2	96	86	78	72	93	84	77	71	80	74	69	77	72	67	73	69	65	63
3	86	75	66	58	84	73	64	58	70	62	56	67	60	55	64	59	54	52
4	79	65	56	48	76	64	55	48	61	53	47	59	52	46	56	50	46	43
5	72	58	48	41	70	57	48	41	54	46	40	52	45	40	50	44	39	37
6	66	52	42	35	64	51	42	35	49	41	35	47	40	34	45	39	34	32
7	61	47	37	31	59	46	37	31	44	36	30	43	35	30	41	35	30	28
8	57	42	33	27	55	42	33	27	40	32	27	39	32	27	38	31	26	24
9	53	39	30	24	51	38	30	24	37	29	24	36	29	24	35	28	24	22
10	50	36	27	22	48	35	27	22	34	27	22	33	26	21	32	26	21	19

LAMPS (number of lamps)

Luminaire budgetary diagram

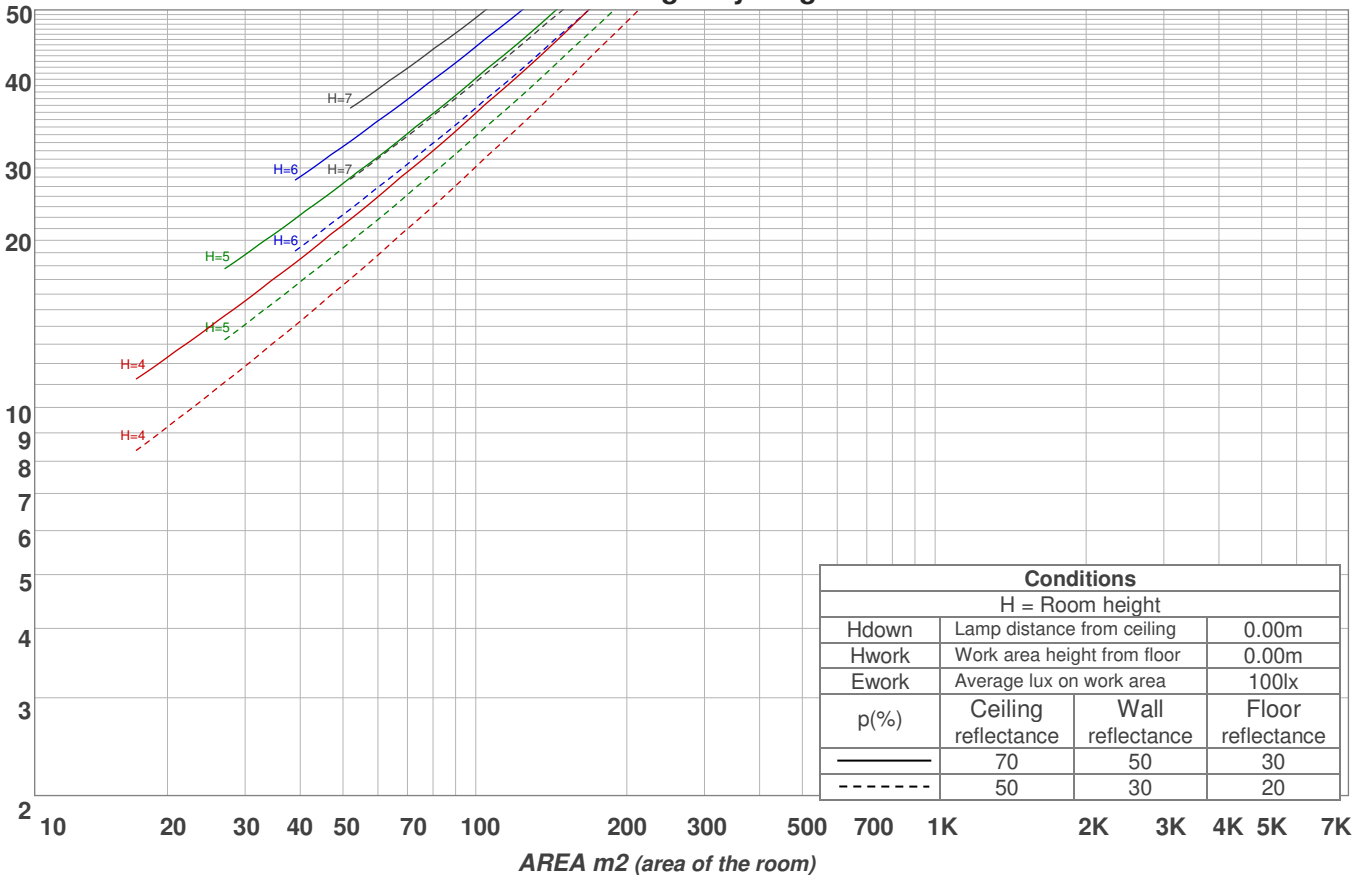

Zonal Lumen Summary

0°-10°	10°-20°	20°-30°	30°-40°	40°-50°	50°-60°	60°-70°	70°-80°	80°-90°
14.4 lm	42.2 lm	66.8 lm	85.8 lm	96.7 lm	97.0 lm	85.3 lm	60.4 lm	26.7 lm
90°-100°	100°-110°	110°-120°	120°-130°	130°-140°	140°-150°	150°-160°	160°-170°	170°-180°
3.91 lm	0.903 lm	0.649 lm	0.590 lm	0.481 lm	0.474 lm	0.301 lm	0.197 lm	0.064 lm



Product name:
SC24-5.0_DRY_B

Date:
2/27/2018

Powering product:
IQ-PH-80-120/24

Output: 146 lm/ft
Peak: 36.4 cd
Power: 5.7 W/ft
PF: 1.0



Light efficiency:



Light quality:



Color temperature:



Beam Angle

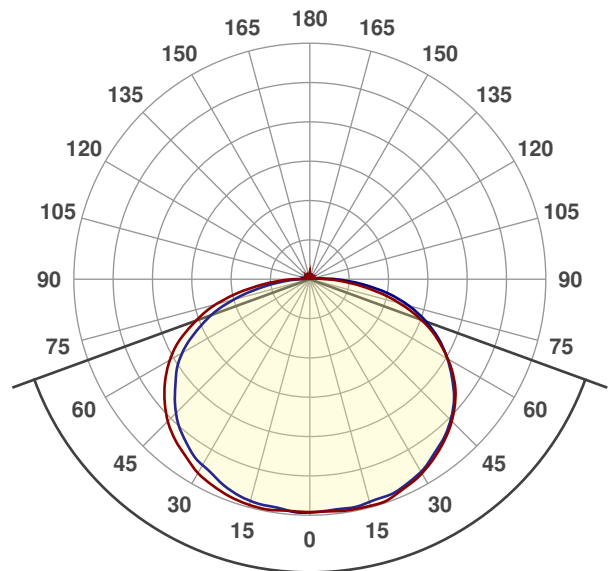

140°



CIE 1931
x: 0.129
y: 0.069

Spectra

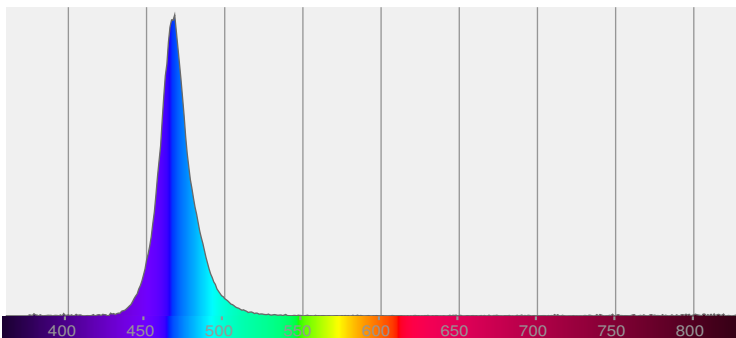

Power

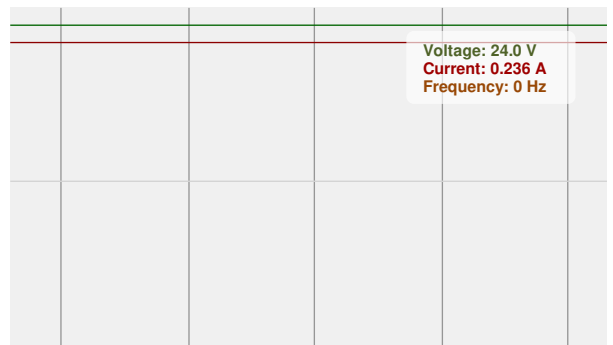

Rf 0.0
Fidelity index Rf

Rg 0.0
Gammut index Rg

Hue Bin	R _f	Graphic shifts (%)	
		Chroma	Hue
1	0	0%	0%
2	0	0%	0%
3	0	0%	0%
4	0	0%	0%
5	0	0%	0%
6	0	0%	0%
7	0	0%	0%
8	0	0%	0%
9	0	0%	0%
10	0	0%	0%
11	0	0%	0%
12	0	0%	0%
13	0	0%	0%
14	0	0%	0%
15	0	0%	0%
16	0	0%	0%

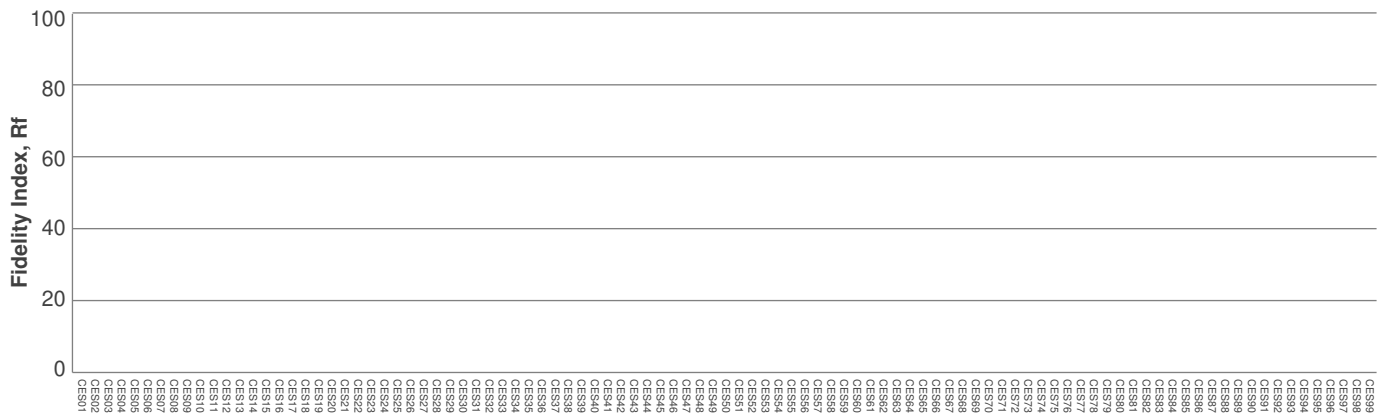
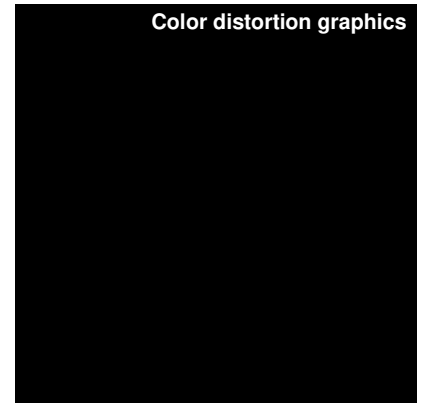
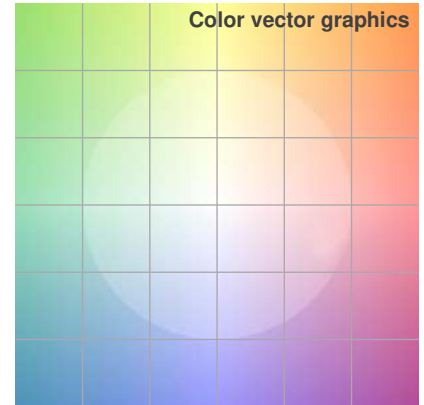
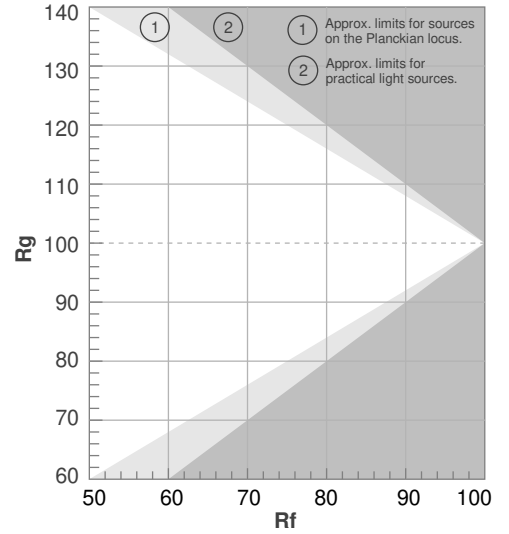

Color Evaluation Sample



Beam Details

SC24-5.0_DRY_B

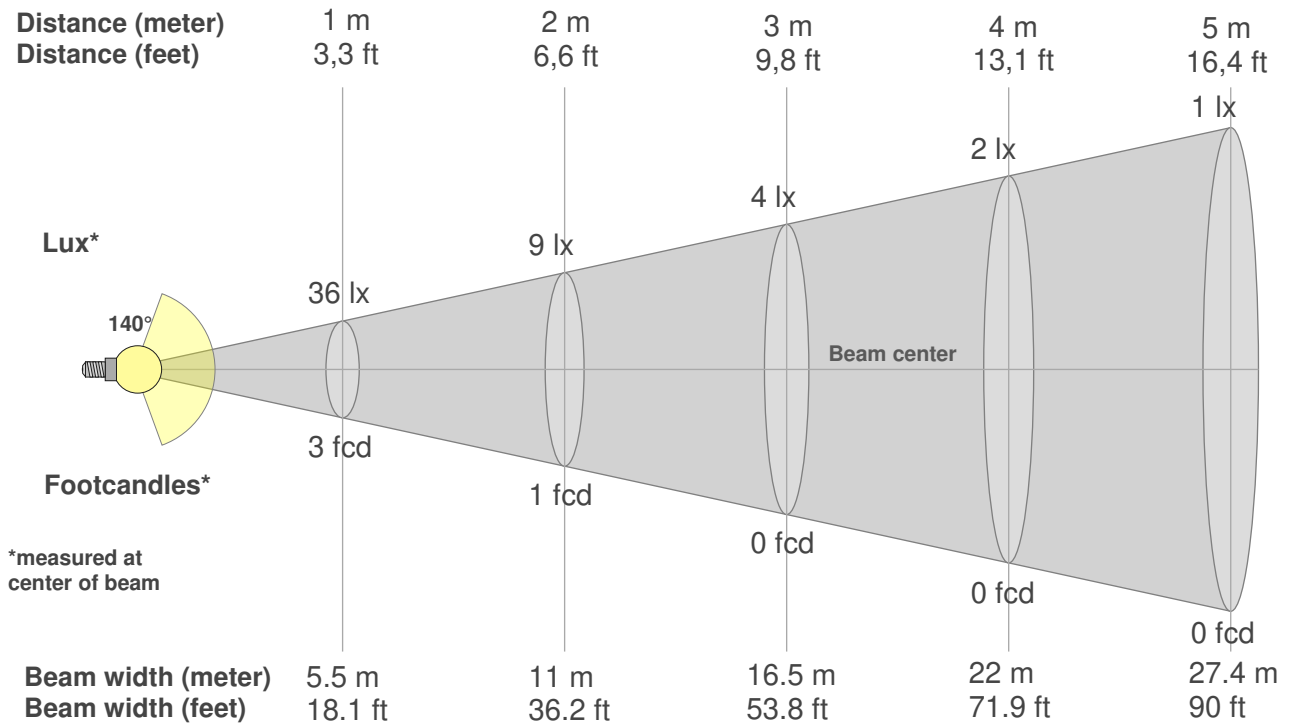

*measured at center of beam

Beam intensities from 1-20m

1m	2m	3m	4m	5m	6m	7m	8m	9m	10m	11m	12m	13m	14m	15m	16m	17m	18m	19m	20m
3.3ft	6.6ft	9.8ft	13.1ft	16.4ft	19.7ft	23ft	26.2ft	29.5ft	32.8ft	36.1ft	39.4ft	42.7ft	45.9ft	49.2ft	52.5ft	55.8ft	59.1ft	62.3ft	65.6ft
36lx	9lx	4lx	2lx	1lx	1lx	1lx	1lx	0lx	0lx	0lx	0lx	0lx	0lx	0lx	0lx	0lx	0lx	0lx	0lx
3.4fcd	0.8fcd	0.4fcd	0.2fcd	0.1fcd	0.1fcd	0.1fcd	0.1fcd	0fcd	0fcd	0fcd	0fcd	0fcd	0fcd	0fcd	0fcd	0fcd	0fcd	0fcd	0fcd

Intensities in 0° c-plane

0°	5°	10°	15°	20°	25°	30°	35°	40°	45°	50°	55°	60°	65°	70°	75°	80°	85°	90°	95°
36.1	36.1	36.3	36.4	36.2	35.5	34.7	33.7	32.5	31.1	29.4	27.3	24.7	21.7	18.3	14.4	10.2	6.1	2.9	1.1
100%	100%	101%	101%	100%	98%	96%	93%	90%	86%	81%	76%	68%	60%	51%	40%	28%	17%	8%	3%

Intensities in 90° c-plane

0°	5°	10°	15°	20°	25°	30°	35°	40°	45°	50°	55°	60°	65°	70°	75°	80°	85°	90°	95°
36.1	36.0	36.0	35.8	35.6	35.2	34.5	33.3	32.2	30.9	29.2	26.9	24.6	22.1	19.2	15.9	12.1	7.8	4.1	1.4
100%	100%	100%	99%	99%	97%	95%	92%	89%	85%	81%	75%	68%	61%	53%	44%	34%	22%	11%	4%

Intensities in 180° c-plane

0°	5°	10°	15°	20°	25°	30°	35°	40°	45°	50°	55°	60°	65°	70°	75°	80°	85°	90°	95°
36.1	36.1	36.3	36.2	35.9	35.4	34.7	33.5	32.5	31.1	29.4	27.4	25.0	22.2	18.7	15.1	10.6	6.3	2.8	0.8
100%	100%	100%	100%	99%	98%	96%	93%	90%	86%	81%	76%	69%	61%	52%	42%	29%	17%	8%	2%

Intensities in 270° c-plane

0°	5°	10°	15°	20°	25°	30°	35°	40°	45°	50°	55°	60°	65°	70°	75°	80°	85°	90°	95°
36.1	36.0	35.8	35.6	35.0	34.1	33.3	32.3	31.0	29.3	27.3	25.2	22.8	19.6	16.2	12.2	8.0	4.3	1.7	0.7
100%	100%	99%	98%	97%	95%	92%	89%	86%	81%	76%	70%	63%	54%	45%	34%	22%	12%	5%	2%

Beam angle 50%	Field angle 10%	Cutoff angle 2,5%	Intensity ratio in 120° cone	Intensity ratio in 90° cone
140°	177°	190°	67.4%	42.8%

ISO candela diagram

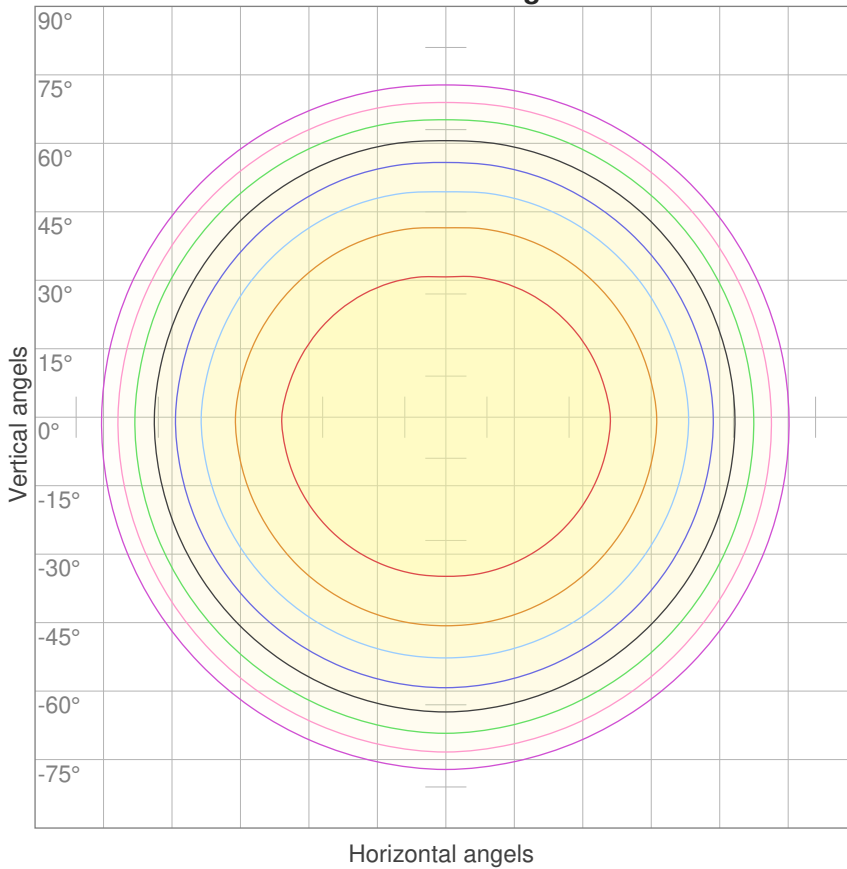

10%	4 cd
20%	7 cd
30%	11 cd
40%	14 cd
50%	18 cd
60%	22 cd
70%	25 cd
80%	29 cd
90%	33 cd

Conditions:

Number of c-planes: 4

Candela at center: 36 cd

ISO lux diagram

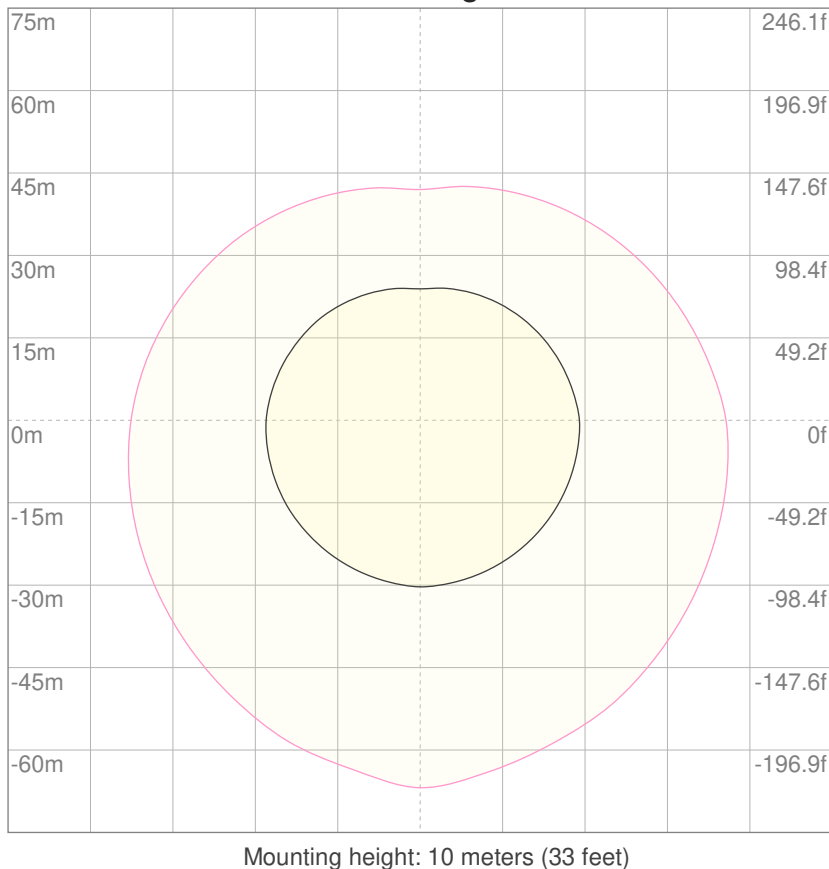

3%	10.8m lx
5%	18.1m lx
10%	36.1m lx
30%	0.108 lx
50%	0.181 lx

Conditions:

Number of c-planes: 4

Lux at center: 0.361 lx

Lux distribution on a surface when lamp is mounted at 10 meters from the surface.



Coefficients of Utilization

Ceiling reflectance	80				70				50			30			10			0			
Wall reflectance	70	50	30	10	70	50	30	10	50	30	10	50	30	10	50	30	10	0			
Floor reflectance	20	20	20	20	20	20	20	20	20	20	20	20	20	20	20	20	20	20	20	20	0
RCR	(RCR: Room Cavity Ratio)																				
	Room Values are expressed as percentage of Lumens delivered to the task surface																				
0	118	118	118	118	115	115	115	115	109	109	109	104	104	104	99	99	99	97			
1	106	100	95	91	103	98	93	89	93	89	85	88	85	82	84	82	79	77			
2	95	86	78	71	92	84	76	70	79	73	68	76	70	66	72	68	64	62			
3	86	74	65	58	83	72	64	57	69	62	56	66	59	54	63	57	53	50			
4	78	65	55	48	75	63	54	47	60	53	46	58	51	45	55	49	44	42			
5	71	58	48	41	69	56	47	40	54	46	39	51	44	39	49	43	38	36			
6	66	51	42	35	64	50	41	35	48	40	34	46	39	34	44	38	33	31			
7	61	46	37	31	59	45	37	30	44	36	30	42	35	29	40	34	29	27			
8	56	42	33	27	55	41	33	27	40	32	26	38	31	26	37	30	26	24			
9	53	38	30	24	51	38	30	24	36	29	24	35	28	23	34	28	23	21			
10	49	35	27	22	48	35	27	21	34	26	21	32	26	21	31	25	21	19			

LAMPS (number of lamps)

Luminaire budgetary diagram

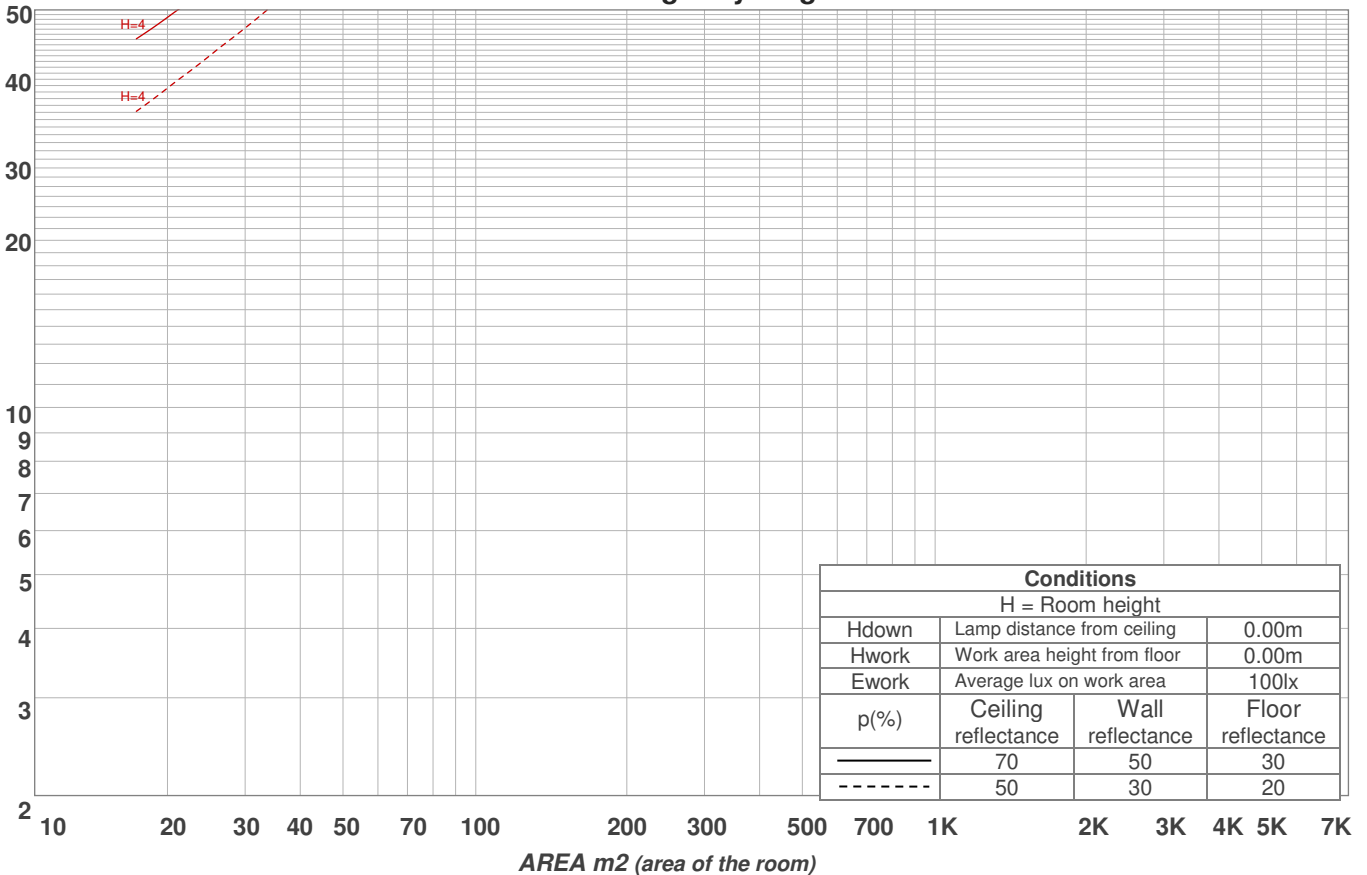

Zonal Lumen Summary

0°-10°	10°-20°	20°-30°	30°-40°	40°-50°	50°-60°	60°-70°	70°-80°	80°-90°
3.44 lm	10.2 lm	16.2 lm	20.8 lm	23.6 lm	23.9 lm	21.2 lm	15.1 lm	6.80 lm
90°-100°	100°-110°	110°-120°	120°-130°	130°-140°	140°-150°	150°-160°	160°-170°	170°-180°
1.29 lm	0.668 lm	0.600 lm	0.510 lm	0.417 lm	0.376 lm	0.287 lm	0.176 lm	0.056 lm

Photometric Details

SC24-5.0_DRY_A



Product name: SC24-5.0_DRY_A	
Date: 6/4/2018	
Powering product: IQ-PH-80-120/24	
<hr/>	
Output:	93.5 lm/ft
Peak:	27.0 cd
Power:	5.4 W/ft
PF:	1.0



Light efficiency:



Light quality:



Color temperature:



Beam Angle

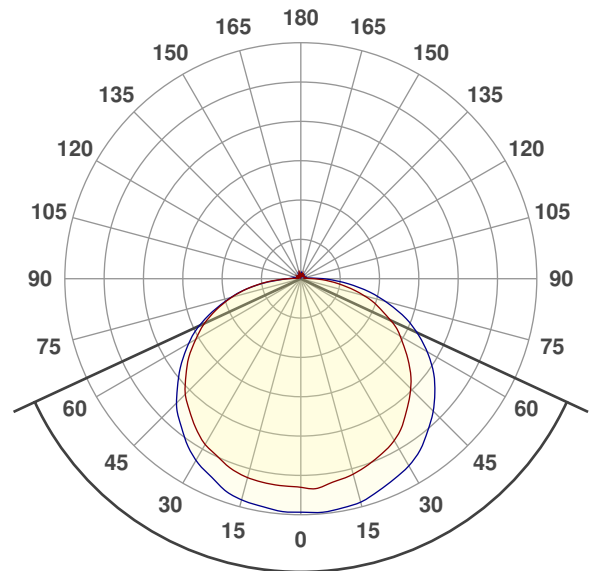

130.3°



CIE 1931
x: 0.578
y: 0.396

Spectra

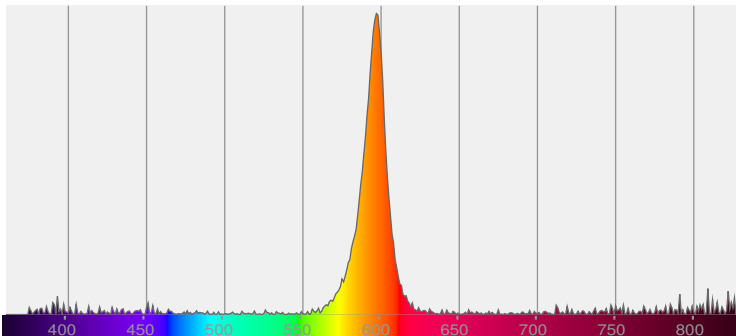

Power

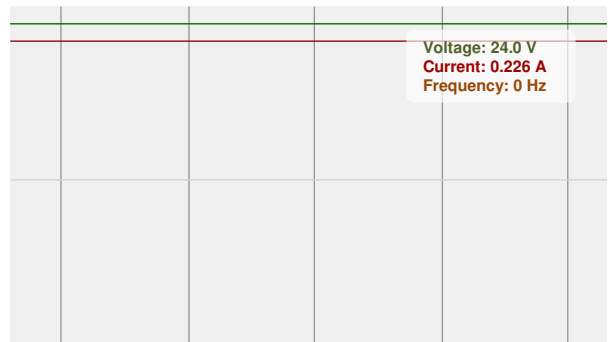

Voltage: 24.0 V
Current: 0.226 A
Frequency: 0 Hz

Color Details

SC24-5.0_DRY_A

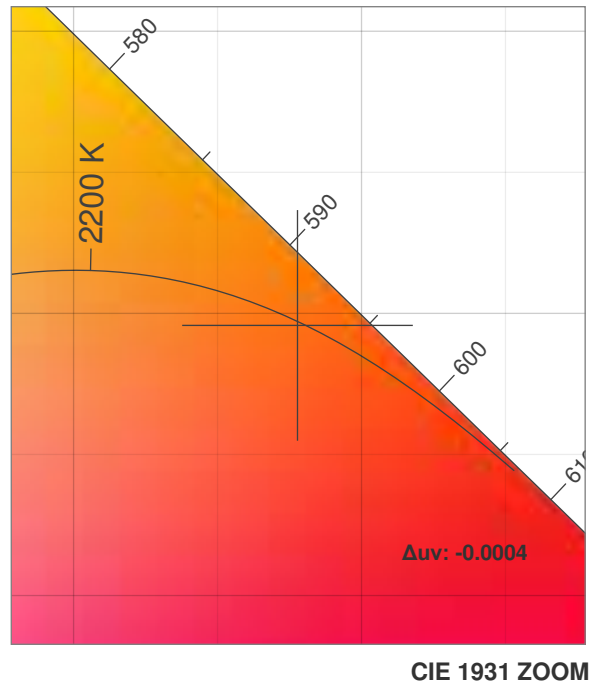
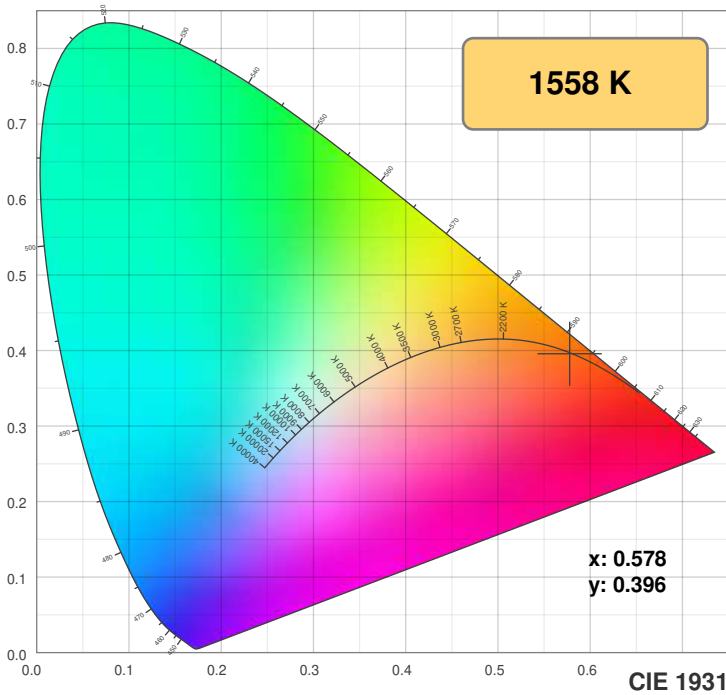

TM30: 3.2

CRI: -19.8 (R1-R8)

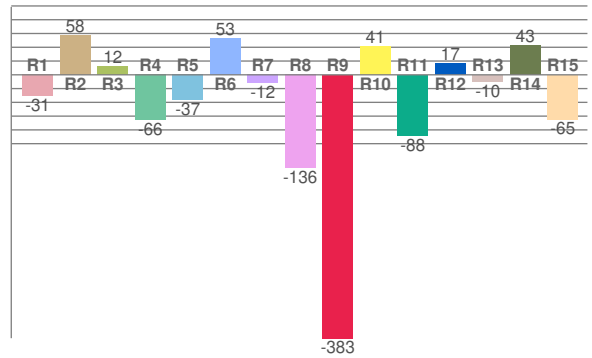
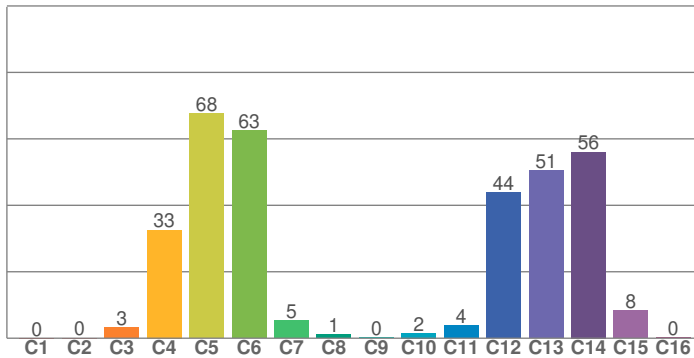

CQS: 12.3

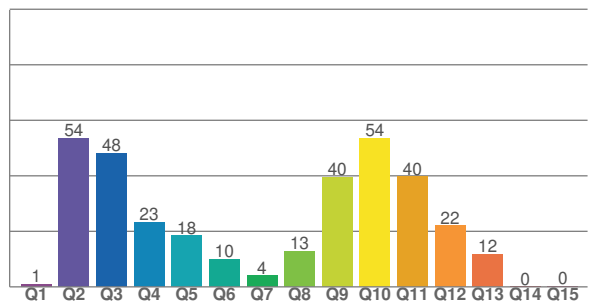

CRI R values, only R1-R8 are used to calculate final CRI value

R1	R2	R3	R4	R5	R6	R7	R8	R9	R10	R11	R12	R13	R14	R15
-30.9	57.6	12.1	-65.6	-36.5	52.7	-11.9	-135.5	-382.5	40.7	-88.3	17.0	-9.9	43.1	-64.9

TM30 C values, 16 binned values out of total of 99 C values

C1	C2	C3	C4	C5	C6	C7	C8	C9	C10	C11	C12	C13	C14	C15	C16
0.0	0.0	3.2	32.5	67.6	62.6	5.3	1.1	0.2	1.5	3.8	43.9	50.5	56.0	8.3	0.3

CQS Q values

Q1	Q2	Q3	Q4	Q5	Q6	Q7	Q8	Q9	Q10	Q11	Q12	Q13	Q14	Q15
0.9	53.7	48.2	23.4	18.4	10.0	4.0	12.8	39.6	53.6	39.7	22.1	11.8	0.1	0.2

Color parameters

Color temperature	Color rendering index	Red component	Color fidelity	Color gamut	Color quality scale	Color coordinate cie 1931	Color coordinate cie 1931	Color coordinate	Color coordinate	Color deviation from black body
CCT	CRI	CRI R9	TM30 Rf	TM30 Rg	CQS	x	y	u	v	Δuv
1558 K	-19.8	-382.5	3.2	28.0	12.3	0.578	0.396	0.351	0.360	-0.0004

TM30 Details

SC24-5.0_DRY_A



Rf 3.2
Fidelity index Rf

Rg 28.0
Gammut index Rg

Hue Bin	R _i	Graphic shifts (%)	
		Chroma	Hue
1	0	-80%	17%
2	0	-58%	65%
3	3	-8%	79%
4	33	26%	50%
5	68	46%	8%
6	63	16%	-32%
7	5	-29%	-49%
8	1	-68%	-39%
9	0	-70%	22%
10	2	-53%	47%
11	4	-20%	56%
12	44	-5%	26%
13	51	7%	-12%
14	56	7%	-43%
15	8	-33%	-64%
16	0	-67%	-42%

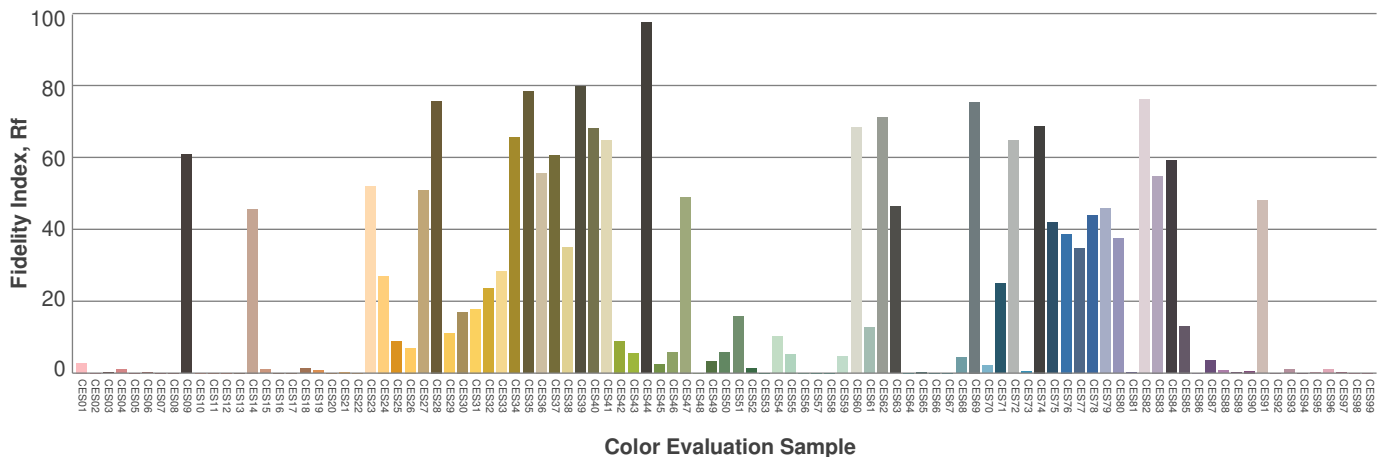
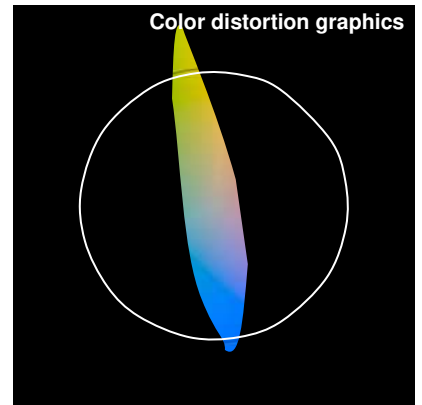
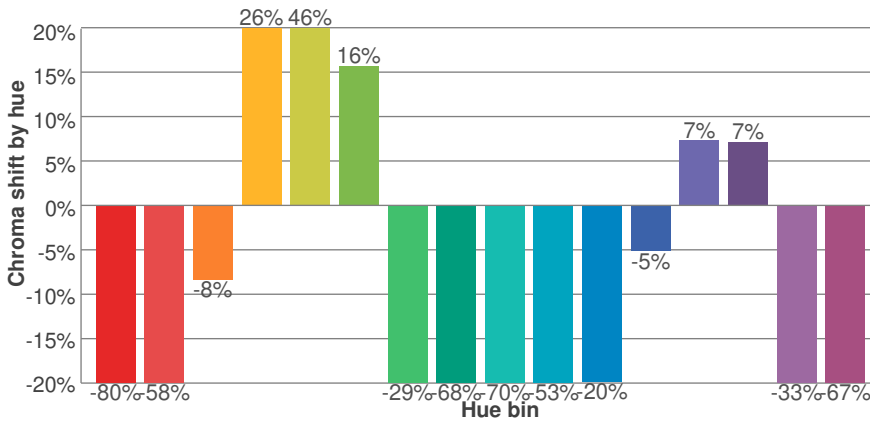
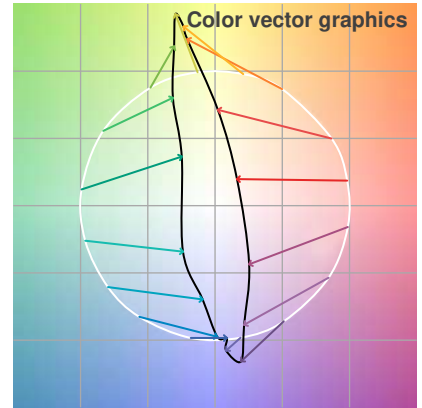
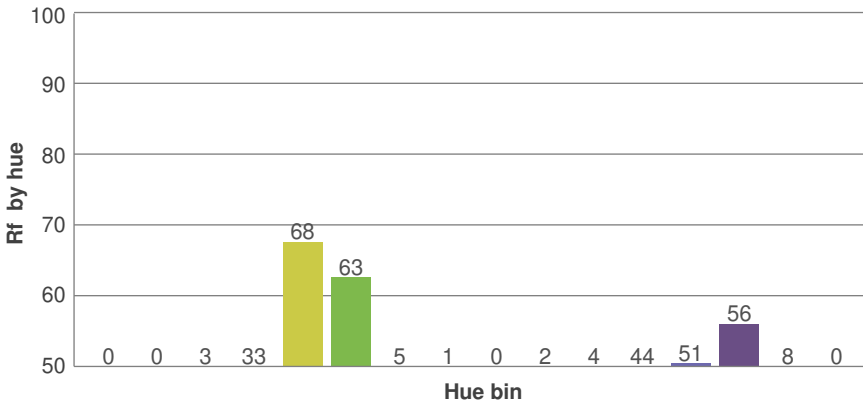
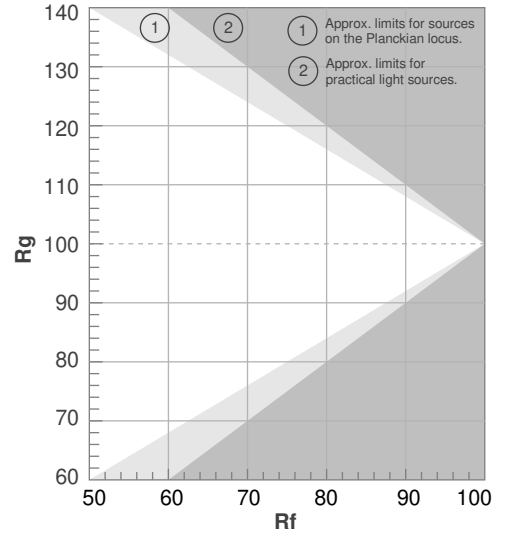

Photometric Details

SC24-5.0_DRY_A590



Product name: SC24-5.0_DRY_A590	
Date: 6/12/2018	
Powering product: IQ-PH-80-120/24	
<hr/>	
Output:	71.1 lm/ft
Peak:	18.7 cd
Power:	3.4 W/ft
PF:	1.0



Light efficiency:



Light quality:

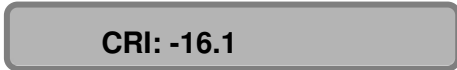

Color temperature:

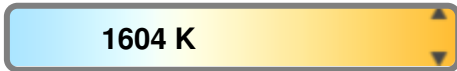

Beam Angle

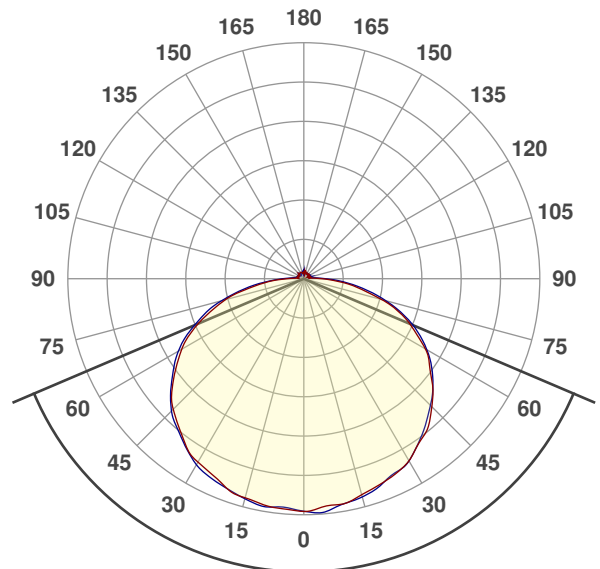

133.9°

CIE 1931
x: 0.571
y: 0.397



Spectra

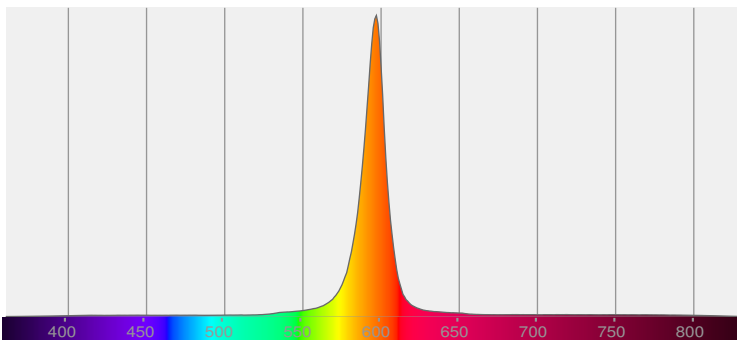

Power

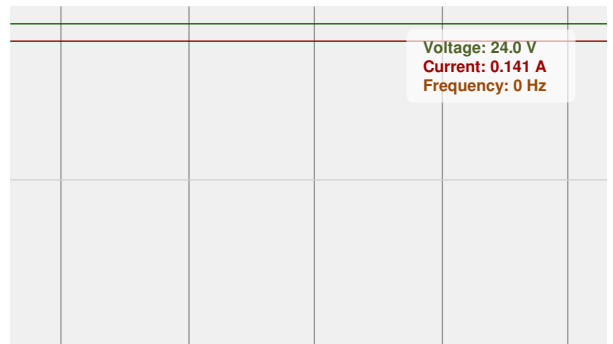

Color Details

SC24-5.0_DRY_A590

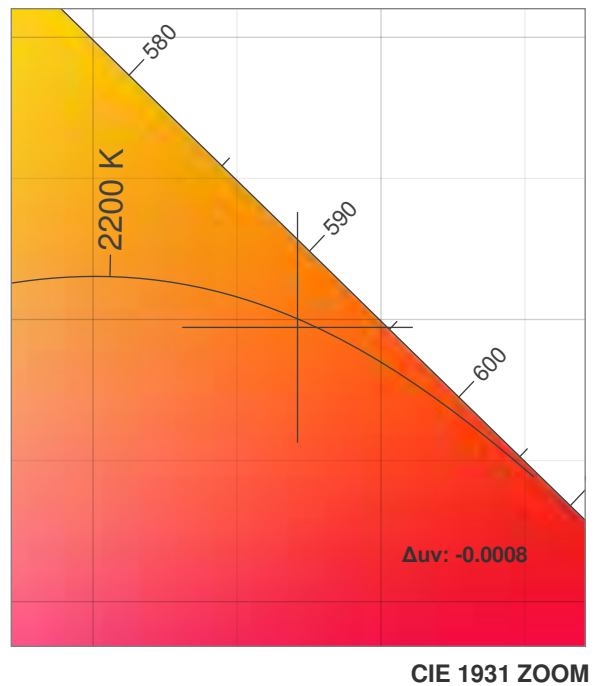
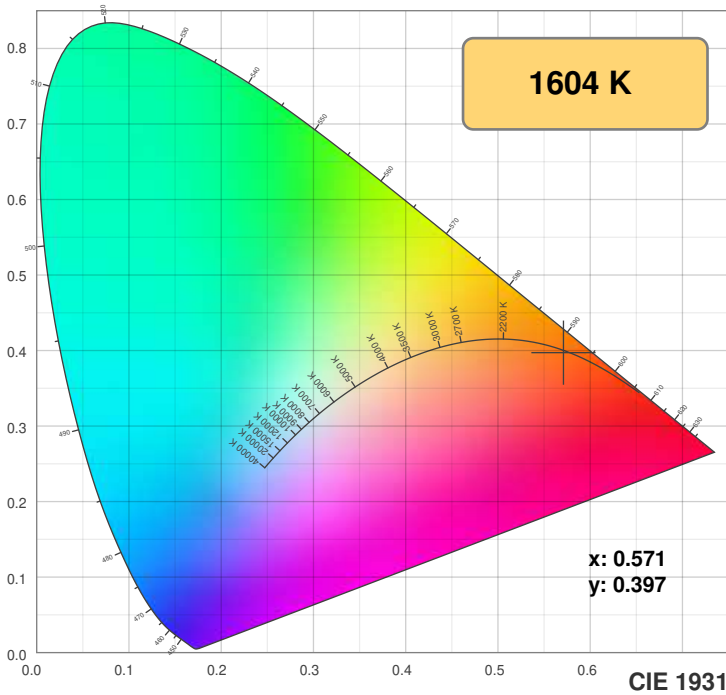

TM30: 4.8

CRI: -16.1 (R1-R8)

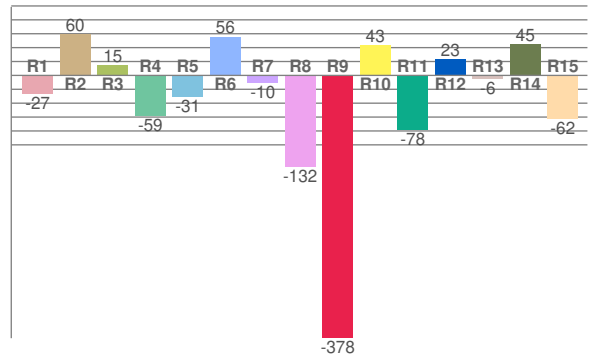
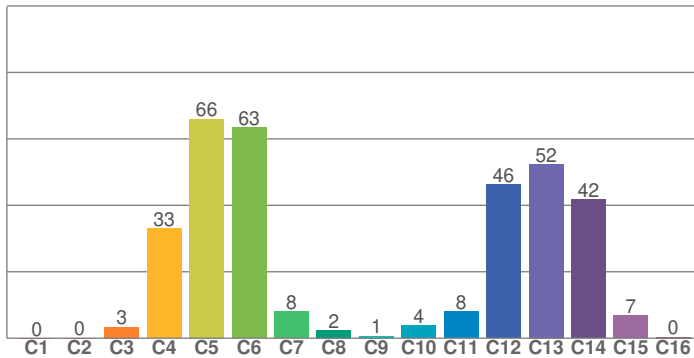

CRI R values, only R1-R8 are used to calculate final CRI value

R1	R2	R3	R4	R5	R6	R7	R8	R9	R10	R11	R12	R13	R14	R15
-26.8	59.6	14.9	-58.6	-30.7	55.8	-10.5	-132.4	-378.4	43.4	-78.1	23.4	-5.7	44.9	-62.1

TM30 C values, 16 binned values out of total of 99 C values

C1	C2	C3	C4	C5	C6	C7	C8	C9	C10	C11	C12	C13	C14	C15	C16
0.0	0.0	3.4	33.0	66.0	63.4	8.1	2.4	0.7	3.8	8.0	46.3	52.4	41.7	6.8	0.4

CQS Q values

Q1	Q2	Q3	Q4	Q5	Q6	Q7	Q8	Q9	Q10	Q11	Q12	Q13	Q14	Q15
1.1	56.4	51.1	26.2	20.9	12.7	6.2	15.5	41.4	55.6	40.9	22.5	11.7	0.1	0.3

CQS: 13.8

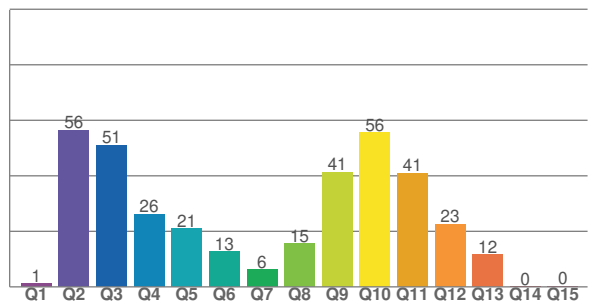

Color parameters

Color temperature	Color rendering index	Red component	Color fidelity	Color gamut	Color quality scale	Color coordinate cie 1931	Color coordinate cie 1931	Color coordinate	Color coordinate	Color deviation from black body
CCT	CRI	CRI R9	TM30 Rf	TM30 Rg	CQS	x	y	u	v	Δuv
1604 K	-16.1	-378.4	4.8	33.7	13.8	0.571	0.397	0.345	0.360	-0.0008

TM30 Details

SC24-5.0_DRY_A590



Rf 4.8
Fidelity index Rf

Rg 33.7
Gammut index Rg

Hue Bin	R _i	Graphic shifts (%)	
		Chroma	Hue
1	0	-77%	16%
2	0	-56%	63%
3	3	-5%	77%
4	33	26%	48%
5	66	46%	7%
6	63	16%	-30%
7	8	-27%	-46%
8	2	-62%	-37%
9	1	-62%	19%
10	4	-49%	42%
11	8	-18%	51%
12	46	-7%	23%
13	52	5%	-13%
14	42	0%	-53%
15	7	-33%	-61%
16	0	-66%	-39%

