

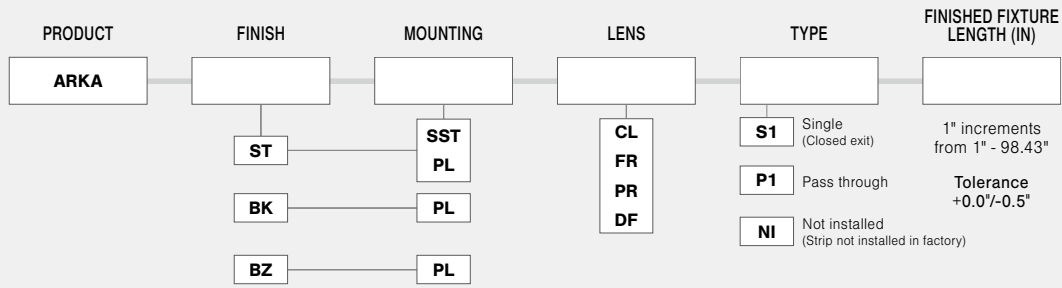

ARKA

EXTRUSIONS - ALUMINUM

Model: iQA



- NOTES:**
- UL Listed when assembled with STRIP LEDs at Q-Tran
 - NRTL Listed for install in Storage Areas with Clothing, NEC Field 410.2 and 410.16 when assembled as a fixture, with 4.0 w/ft or less, at Q-Tran facility (Not applicable for encapsulation)
 - Field modifications must comply with Q-Tran's installation methods otherwise warranty is null and void

FINISH

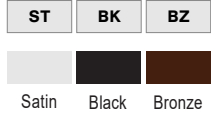

MOUNTING

NOTE: 2 clips provided for 4' or less; 4 clips provided for greater than 4'

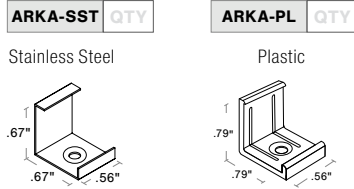

LENS with LED visibility

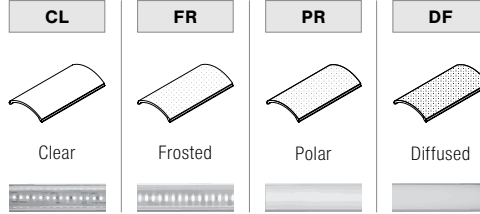

DIMENSIONS

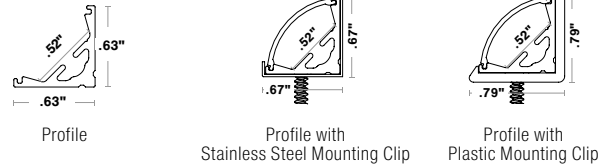

TYPE

SINGLE (Input only)

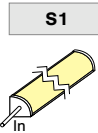

PASS THROUGH (Input/Output)

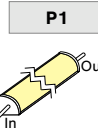

ORDER EXAMPLE

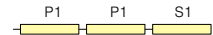

END CAPS



LENGTH (IN) : Add to nominal LED length for fixture length



$$\begin{aligned} & \text{Endcap\#1} \\ & \text{Endcap\#2} \\ & \text{Space to solder wire} \\ \text{S1 } & .07'' + .07'' + .25'' = .39'' \\ \text{P1 } & .07'' + .07'' + 2(.25'') = .64'' \end{aligned}$$

CUT OFF



WIRE WAY

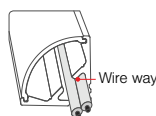

COMPATIBLE LEDs

STATIC WHITE (SW)				DYNAMIC WHITE (DW)				STATIC COLOR (SC)				RGB				RGBW			
DRY	DMP	WET	ENC	DRY	DMP	WET	ENC	DRY	DMP	WET	ENC	DRY	DMP	WET	ENC	DRY	DMP	WET	ENC
✓	✓	✓	✗	✓	✓	✓	✗	✓	✓	✓	✗	✓	✗	✓	✗	✓	✓	✓	✗
✓ = Compatible				✓ = NOT Compatible with 6.0 & 7.5 strips				✗ = NOT Compatible											

PROJECT NAME	DATE	COMPANY	TYPE	NOTE

RESOURCE GUIDE

EXTRUSIONS - CORNER - ARKA

Model: iQA



FINISH

SATIN



SATIN ANODIZED
MATTE FINISH
GREY ENDCAPS

BLACK

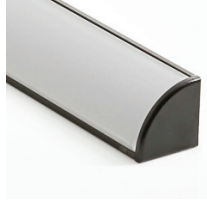

BLACK ANODIZED
MATTE FINISH
BLACK ENDCAPS

BRONZE



BRONZE ANODIZED
MATTE FINISH
BRONZE ENDCAPS

MOUNTING TYPE - CORNER



MOUNTING - HARDWARE

Stainless Steel Clip (SST)

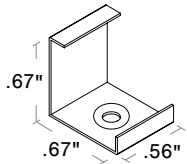

2 clips provided for 4' or less;
4 clips provided for greater than 4'

- Stainless Steel
- Indoor/Outdoor
- #4 x 5/8" Flat Head SS (1 per clip included)

Plastic Clip (PL)

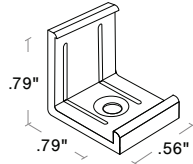

2 clips provided for 4' or less;
4 clips provided for greater than 4'

- Plastic
- Indoor/Outdoor
- #4 x 5/8" Flat Head SS (1 per clip included)

VHB-STD & VHB-CON (see Accessory cutsheet)

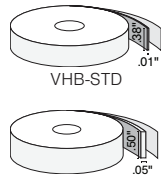

- Double sided strong adhesive tape
- VHB-STD is for Indoor use
- VHB-CON bonds to concrete

832 (see Accessory cutsheet)

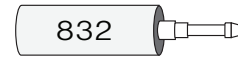

- Strong adhesive
- Not submersible, For dry and wet locations only

Q-ANGLE & PIVOT BRACKET (see Accessory cutsheet)

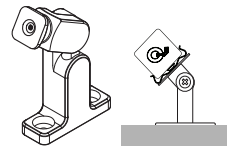

Q-ANGLE PIVOT

- Adjustable mounting bracket
- Q-Angle: Indoor/Outdoor
- Pivot Bracket: Indoor

LENS

CL Clear

FR Frosted

PR Polar

DF Diffused



CUT OFF

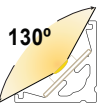

Clear 130°

RESOURCE GUIDE

EXTRUSIONS - CORNER - ARKA

Model: iQA



CONNECTORS/WIRE

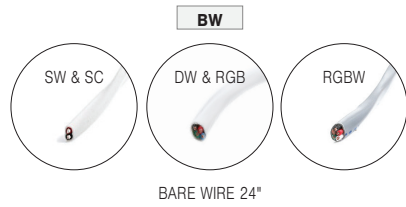

STATIC WHITE AND STATIC COLOR ONLY



LIGHT ORIENTATION



TYPE To order a bare extrusion without a strip installed in Q-Tran factory, choose **NI** (Not Installed) for your Type option

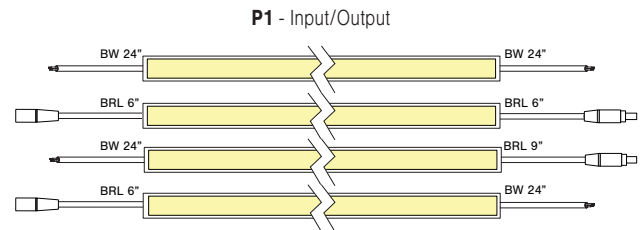
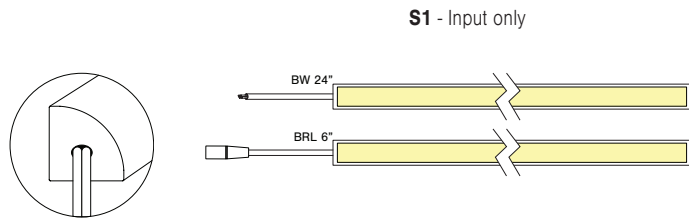

RESOURCE GUIDE - COMPATIBILITY

EXTRUSIONS & STRIPS



STRIP AND EXTRUSION COMPATIBILITY

EXTRUSIONS	STATIC WHITE 1.5 - 7.5 W/ft				DYNAMIC WHITE 6.0 W/ft				STATIC COLOR 5.0 W/ft				RGB 5.3 W/ft				RGBW 6.0 W/ft				
	DRY	DMP	WET	ENC	DRY	DMP	WET	ENC	DRY	DMP	WET	ENC	DRY	DMP	WET	ENC	DRY	DMP	WET	ENC	
SLIM	◆	◆	◇	✗	✓	✓	✗	✗	✓	✓	◇	✗	✓	✗	✗	✗	✗	✗	✗	✗	✗
WIDE	✓	◆	◆	✗	✓	✓	✓	✗	✓	✓	✓	✗	✓	✗	✓	✗	✓	✓	✓	✓	✗
ROND	✓	◆	✗	✗	✓	✓	✗	✗	✓	✓	✗	✗	✓	✗	✗	✗	✗	✗	✗	✗	✗
VEGA	✓	◆	✗	✗	✓	✓	✗	✗	✓	✓	✗	✗	✓	✗	✗	✗	✗	✗	✗	✗	✗
TORQ	✓	◆	◆	◆	✓	✓	✗	✓	✓	✓	✓	✓	✓	✗	✗	✓	✗	✗	✗	✗	✗
TRE3	✓	◆	◆	✗	✓	✓	✗	✗	✓	✓	✓	✗	✓	✗	✗	✗	✓	✓	✗	✗	✗
ARKA	✓	◆	◆	✗	✓	✓	✓	✗	✓	✓	✓	✗	✓	✗	✓	✗	✓	✓	✗	✗	✗
TELA	✓	◆	◆	✗	✓	✓	✓	✗	✓	✓	✓	✗	✓	✗	✓	✗	✓	✓	✗	✗	✗
VEVE	✓	◆	◆	✗	✓	✓	✗	✗	✓	✓	✓	✗	✓	✗	✗	✗	✓	✓	✗	✗	✗
FLUR	✓	◆	◆	◆	✓	✓	✗	✓	✓	✓	✓	✓	✓	✗	✗	✓	✗	✗	✗	✗	✗
LATO	✓	◆	◆	◆	✓	✓	✗	✓	✓	✓	✓	✓	✓	✗	✗	✓	✗	✗	✗	✗	✗
LALO	✓	◆	◆	◆	✓	✓	✓	✓	✓	✓	✓	✓	✓	✗	✓	✓	✓	✓	✓	✗	✓
TALO	✓	◆	◆	◆	✓	✓	✓	✓	✓	✓	✓	✓	✓	✗	✓	✓	✓	✓	✓	✗	✓
MDIN	◆	◆	✗	✗	✗	✗	✗	✗	✗	✗	✗	✗	✗	✗	✗	✗	✗	✗	✗	✗	✗

- ◆ = NOT Compatible with 6.0 & 7.5 strips
- ◇ = Wet rated but with no lens
- ✓ = Compatible
- ✗ = NOT Compatible

MOUNTING INSTALLATION

EXTRUSIONS - CORNER - ARKA

Model: iQA



MOUNTING NOTE: 2 clips provided for 4' or less;
4 clips provided for greater than 4'

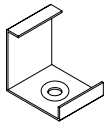

ARKA-SST

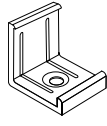

ARKA-PL

Screw Mounting

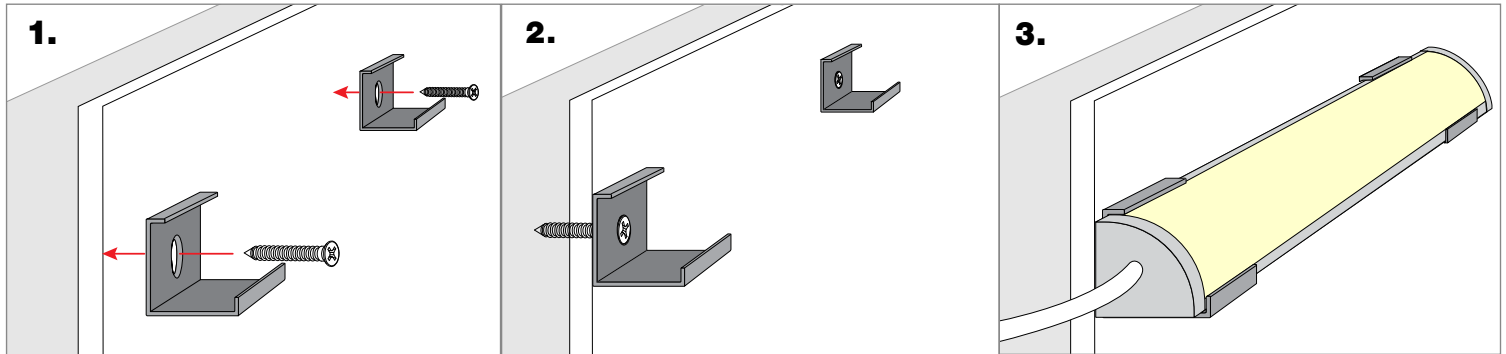

832 Silicone Mounting

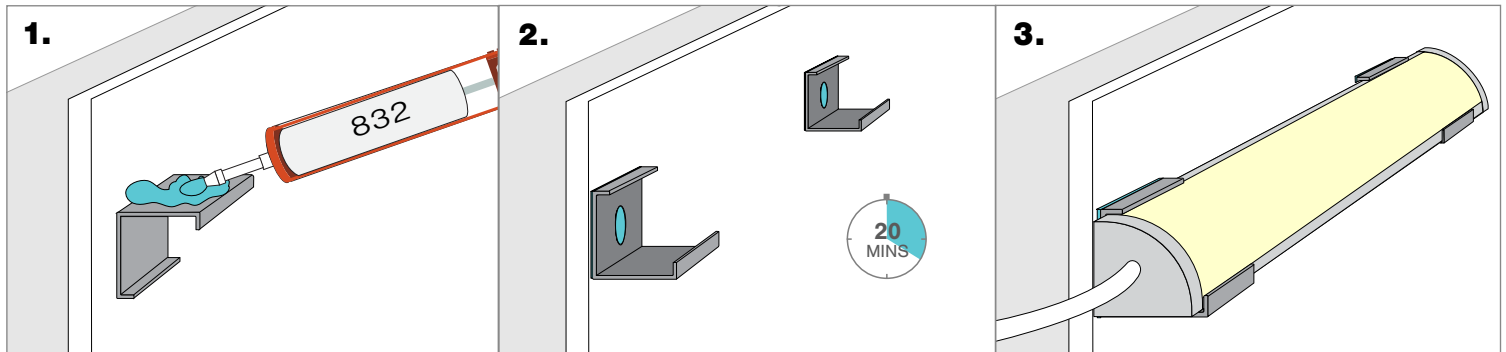

NOTE: 832 Silicone use in a well-ventilated area, 832 Silicone sold with Caulking gun. Do not use in any submersible applications.

VHB Mounting

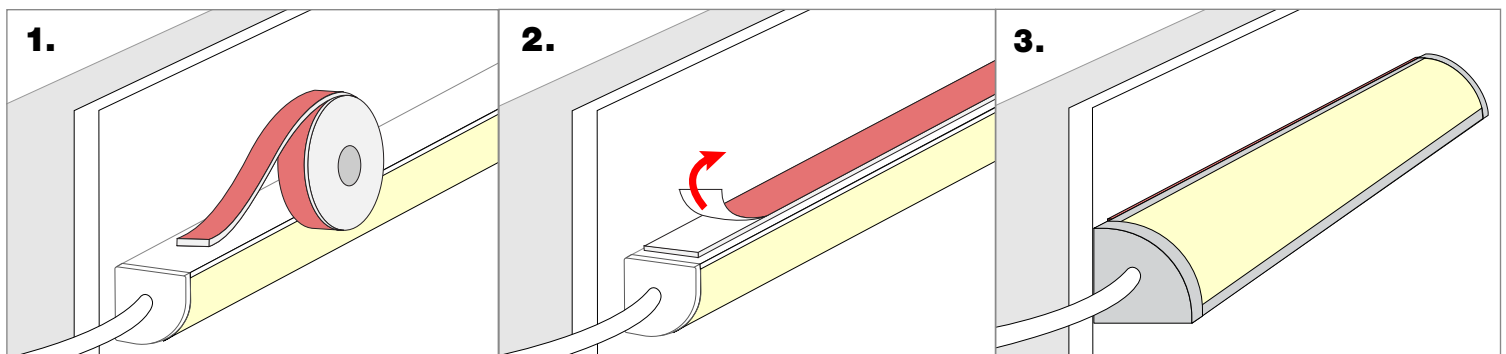

NOTES: • Field modifications must comply with Q-Tran's installation methods otherwise warranty is null and void