

TORQ

EXTRUSIONS - ALUMINUM

Model: iQA

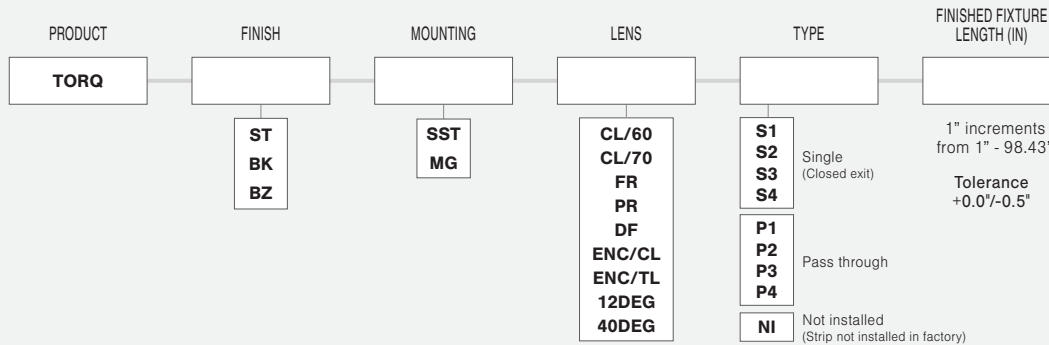

- NOTES:**
- UL Listed when assembled with STRIP LEDs at Q-Tran
 - NRTL Listed for install in Storage Areas with Clothing, NEC Field 410.2 and 410.16 when assembled as a fixture, with 4.0 w/ft or less, at Q-Tran facility (Not applicable for encapsulation)
 - Field modifications must comply with Q-Tran's installation methods otherwise warranty is null and void

FINISH

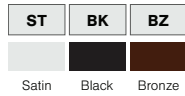

MOUNTING

NOTE: 2 clips provided for 4' or less; 4 clips provided for greater than 4'

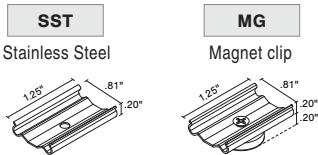

LENS with LED visibility

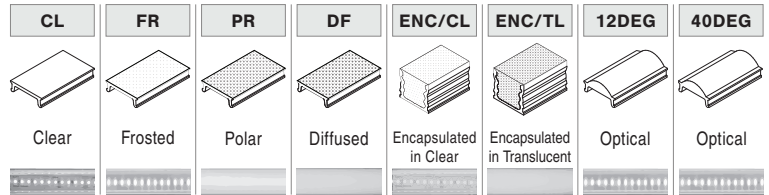

DIMENSIONS

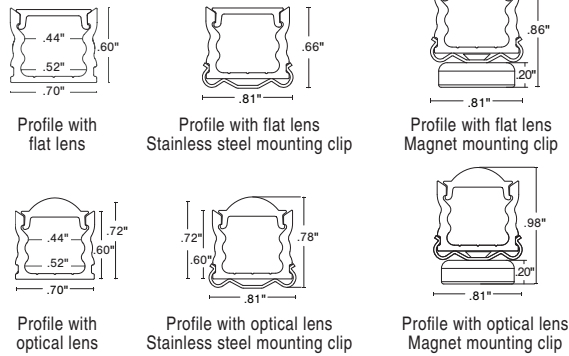

TYPE

SINGLE (Input only)

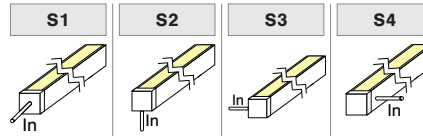

PASS THROUGH (Input/Output)

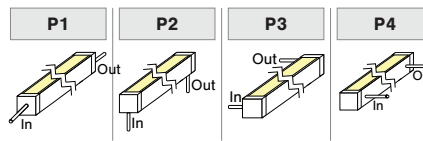

ORDER EXAMPLE

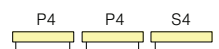

END CAPS

Flat end caps

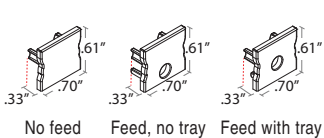

Optical end caps

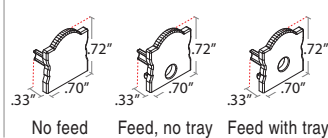

LENGTH (IN) : Add to nominal LED length for fixture length



Endcap#1 Endcap#2
Space to solder wire

$$S1 \quad .08" + .08" + .25" = .41"$$

$$P1 \quad .08" + .08" + 2(.25") = .66"$$

CUT OFF

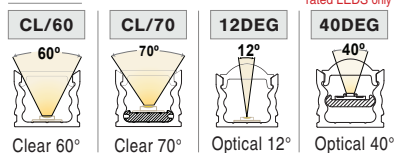

DRY and DMP rated LEDs only

COMPATIBLE LEDs

STATIC WHITE (SW)				DYNAMIC WHITE (DW)				STATIC COLOR (SC)				RGB				RGBW			
DRY	DMP	WET	ENC	DRY	DMP	WET	ENC	DRY	DMP	WET	ENC	DRY	DMP	WET	ENC	DRY	DMP	WET	ENC
✓	✓	✓	✓	✓	✓	✓	✓	✓	✓	✓	✓	✓	✓	✓	✓	✓	✓	✓	✓

✓ = Compatible ✗ = NOT Compatible ◆ = NOT Compatible with 6.0 & 7.5 strips

PROJECT NAME	DATE	COMPANY	TYPE	NOTE