

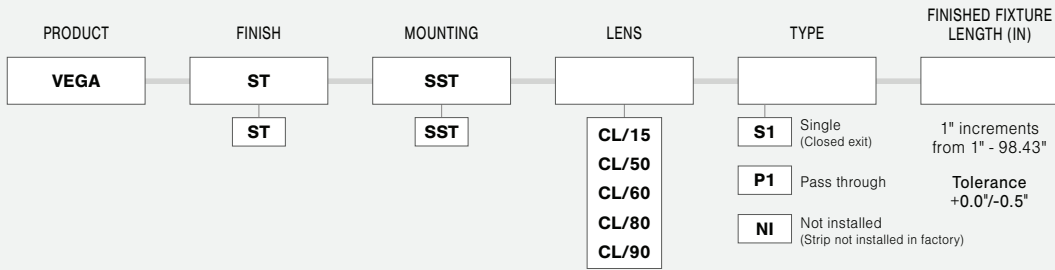

VEGA

EXTRUSIONS - ALUMINUM

Model: iQA



- NOTES:**
- UL Listed when assembled with STRIP LEDs at Q-Tran
 - NRTL Listed for install in Storage Areas with Clothing, NEC Field 410.2 and 410.16 when assembled as a fixture, with 4.0 w/ft or less, at Q-Tran facility (Not applicable for encapsulation)
 - Field modifications must comply with Q-Tran's installation methods otherwise warranty is null and void

FINISH



MOUNTING

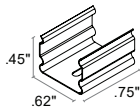

LENS with LED visibility

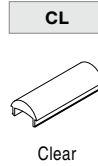

DIMENSIONS

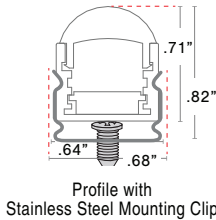
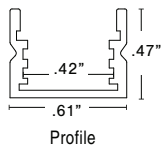

TYPE

SINGLE (Input only)

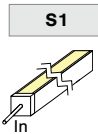

PASS THROUGH (Input/Output)

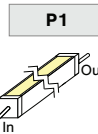

ORDER EXAMPLE

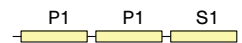

END CAPS

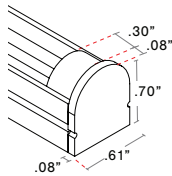

LENGTH (IN) : Add to nominal LED length for fixture length

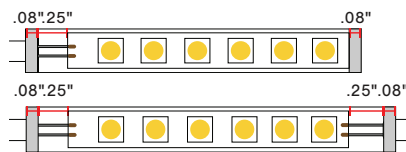

$$\begin{aligned} & \text{Endcap\#1} \\ & \text{Endcap\#2} \\ & \text{Space to solder wire} \\ \text{S1 } & .08'' + .08'' + .25'' = .41'' \\ \text{P1 } & .08'' + .08'' + 2(.25'') = .66'' \end{aligned}$$

CUT OFF

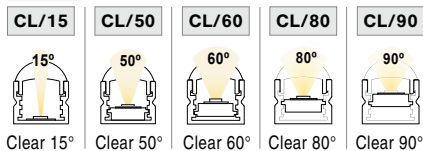

COMPATIBLE LEDs

STATIC WHITE (SW)				DYNAMIC WHITE (DW)				STATIC COLOR (SC)				RGB				RGBW			
DRY	DMP	WET	ENC	DRY	DMP	WET	ENC	DRY	DMP	WET	ENC	DRY	DMP	WET	ENC	DRY	DMP	WET	ENC
✓	✓	✗	✗	✓	✓	✗	✗	✓	✓	✗	✗	✓	✓	✗	✗	✗	✗	✗	✗

✓ = Compatible ✗ = NOT Compatible ◆ = NOT Compatible with 6.0 & 7.5 strips

PROJECT NAME	DATE	COMPANY	TYPE	NOTE

RESOURCE GUIDE

EXTRUSIONS - SURFACE - VEGA

Model: iQA



FINISH

SATIN



SATIN ANODIZED
MATTE FINISH
GREY ENDCAPS

MOUNTING TYPE - SURFACE

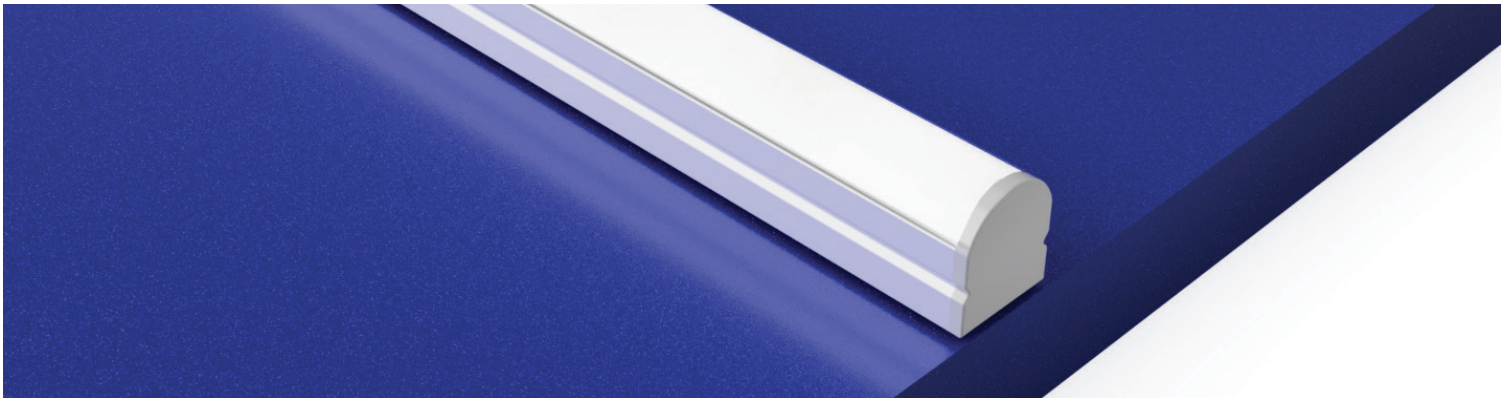

MOUNTING - HARDWARE

Stainless Steel Clip (VEGA-SST)

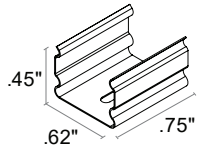

2 clips provided for 4' or less;
4 clips provided for greater than 4'

- Stainless Steel
- Indoor/Outdoor
- #4 x 5/8" Flat Head SS (1 per clip included)

VHB-STD & VHB-CON (see Accessory cutsheet)

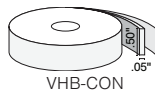
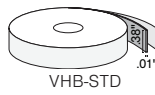

- Double sided strong adhesive tape
- VHB-STD is for Indoor use
- VHB-CON bonds to concrete

832 (see Accessory cutsheet)



- Strong adhesive
- Not submersible, For dry and wet locations only

Q-ANGLE (see Accessory cutsheet)

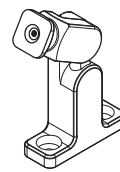

- Adjustable mounting bracket
- Indoor/Outdoor

PIVOT BRACKET (see Accessory cutsheet)



- Adjustable mounting bracket
- Indoor

LENS

CL Clear



CUT OFF

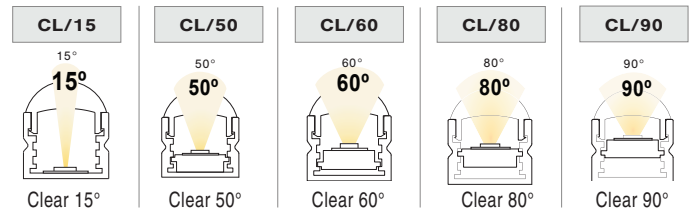

RESOURCE GUIDE

EXTRUSIONS - SURFACE - VEGA

Model: iQA



CONNECTORS/WIRE

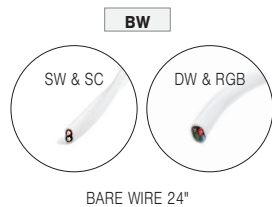

STATIC WHITE AND STATIC COLOR ONLY



LIGHT ORIENTATION

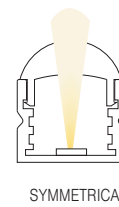

TYPE To order a bare extrusion without a strip installed in Q-Tran factory, choose **NI** (Not Installed) for your Type option

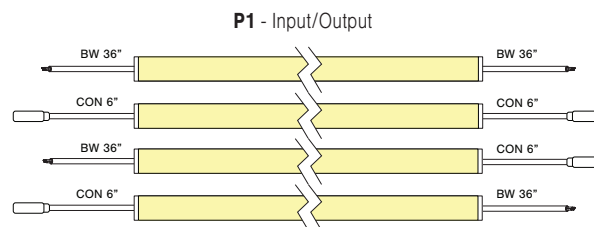
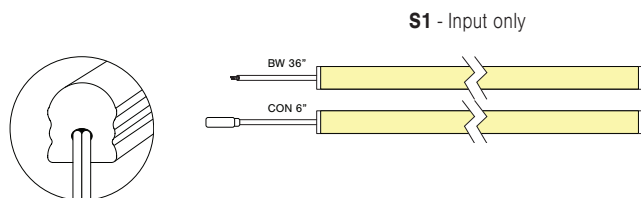

RESOURCE GUIDE - COMPATIBILITY

STRIP & EXTRUSION



EXTRUSIONS	STATIC WHITE				DYNAMIC WHITE				STATIC COLOR				RGB				RGBW				
	1.5 - 7.5 W/ft				IA5.0W/ft	6.0 W/ft				5.0 W/ft				6.0 W/ft				6.0 W/ft			
	DRY	DMP	WET	ENC	DRY	DRY	DMP	WET	ENC	DRY	DMP	WET	ENC	DRY	DMP	WET	ENC	DRY	DMP	WET	ENC
SLIM	✓	◆	◇	✗	✓	✓	✓	✗	✗	✓	✓	◇	✗	✓	✓	✗	✗	✗	✗	✗	✗
WIDE	✓	◆	◇	✗	✓	✓	✓	✓	✗	✓	✓	✓	✗	✓	✓	✓	✗	✓	✓	✓	✗
ROND	✓	◆	✗	✗	✓	✓	✓	✗	✗	✓	✓	✗	✗	✓	✓	✗	✗	✗	✗	✗	✗
VEGA	✓	◆	✗	✗	✓	✓	✓	✗	✗	✓	✓	✗	✗	✓	✓	✗	✗	✗	✗	✗	✗
TORQ	✓	◆	◇	◇	✓	✓	✓	✗	✗	✓	✓	✓	✓	✓	✓	✗	✓	✗	✗	✗	✗
TRE3	✓	◆	◇	✗	✓	✓	✓	✗	✗	✓	✓	✓	✗	✓	✓	✗	✗	✓	✓	✗	✗
ARKA	✓	◆	◇	✗	✓	✓	✓	✓	✗	✓	✓	✓	✗	✓	✓	✓	✗	✓	✓	✗	✗
TELA	✓	◆	◇	✗	✓	✓	✓	✓	✗	✓	✓	✓	✗	✓	✓	✓	✗	✓	✓	✗	✗
VEVE	✓	◆	◇	✗	✓	✓	✓	✗	✗	✓	✓	✓	✗	✓	✓	✗	✗	✓	✓	✗	✗
FLUR	✓	◆	◇	◇	✓	✓	✓	✗	✓	✓	✓	✓	✓	✓	✓	✗	✓	✗	✗	✗	✗
LATO	✓	◆	◇	◇	✓	✓	✓	✗	✓	✓	✓	✓	✓	✓	✓	✗	✓	✗	✗	✗	✗
LALO	✓	◆	◇	◇	✓	✓	✓	✓	✓	✓	✓	✓	✓	✓	✓	✓	✓	✓	✗	✓	✓
TALO	✓	◆	◇	◇	✓	✓	✓	✓	✓	✓	✓	✓	✓	✓	✓	✓	✓	✓	✗	✓	✓
MDIN	●	◆	✗	✗	✓	✓	✓	✗	✗	✓	✓	✗	✗	✓	✓	✗	✗	✓	✓	✗	✗

✓ = Compatible
 ✗ = NOT Compatible
 ◆ = NOT Compatible with 6.0 & 7.5 strips
 ◇ = Wet rated but with no lens
 ● = NOT Compatible with 7.5 strip

EXTRUSIONS	STATIC WHITE - HE															
	1.5 W/ft				3.0 W/ft				6.0 W/ft				9.0 W/ft			
	DRY	DMP	WET	ENC	DRY	DMP	WET	ENC	DRY	DMP	WET	ENC	DRY	DMP	WET	ENC
SLIM	✗	✗	✗	✗	✗	✗	✗	✗	✗	✗	✗	✗	✗	✗	✗	✗
WIDE	✓	✗	✓	✗	✓	✗	✓	✗	✓	✗	✓	✗	✗	✗	✗	✗
ROND	✗	✗	✗	✗	✗	✗	✗	✗	✗	✗	✗	✗	✗	✗	✗	✗
VEGA	✗	✗	✗	✗	✗	✗	✗	✗	✗	✗	✗	✗	✗	✗	✗	✗
TORQ	✓	✗	✗	✗	✓	✗	✗	✗	✓	✗	✗	✗	✓	✗	✗	✗
TRE3	✓	✗	✗	✗	✓	✗	✗	✗	✓	✗	✗	✗	✗	✗	✗	✗
ARKA	✓	✗	✗	✗	✓	✗	✗	✗	✓	✗	✗	✗	✗	✗	✗	✗
TELA	✓	✗	✗	✗	✓	✗	✗	✗	✓	✗	✗	✗	✗	✗	✗	✗
VEVE	✓	✗	✗	✗	✓	✗	✗	✗	✓	✗	✗	✗	✗	✗	✗	✗
FLUR	✓	✗	✗	✗	✓	✗	✗	✗	✓	✗	✗	✗	✓	✗	✗	✗
LATO	✓	✗	✗	✗	✓	✗	✗	✗	✓	✗	✗	✗	✗	✗	✗	✗
LALO	✓	✗	✗	✗	✓	✗	✗	✗	✓	✗	✗	✗	✗	✗	✗	✗
TALO	✓	✗	✗	✗	✓	✗	✗	✗	✓	✗	✗	✗	✗	✗	✗	✗
MDIN	✓	✗	✗	✗	✓	✗	✗	✗	✓	✗	✗	✗	✗	✗	✗	✗

✓ = Compatible
 ✗ = NOT Compatible

MOUNTING INSTALLATION

EXTRUSIONS - SURFACE - VEGA

Model: iQA



MOUNTING NOTE: 2 clips provided for 4' or less;
4 clips provided for greater than 4'

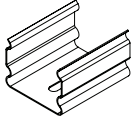

VEGA-SST

Screw Mounting

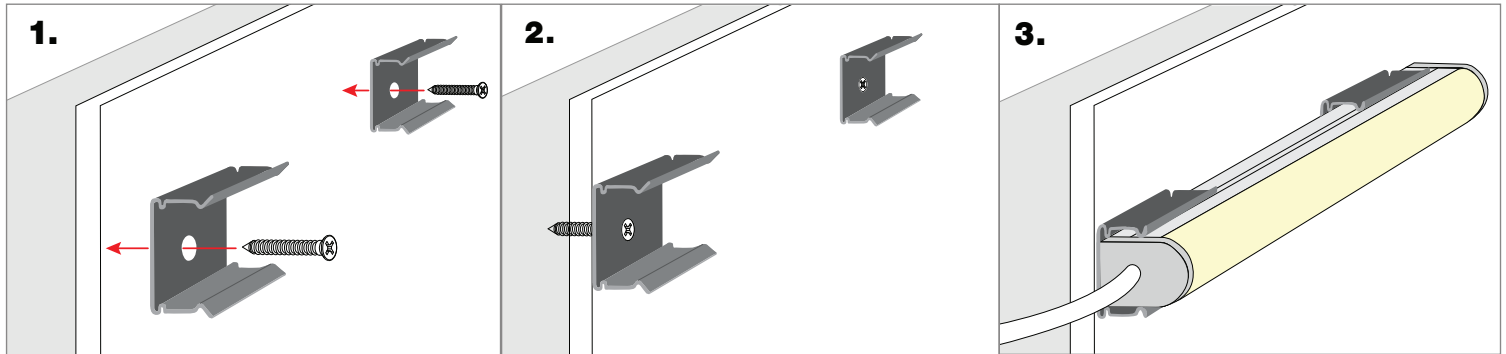

832 Silicone Mounting

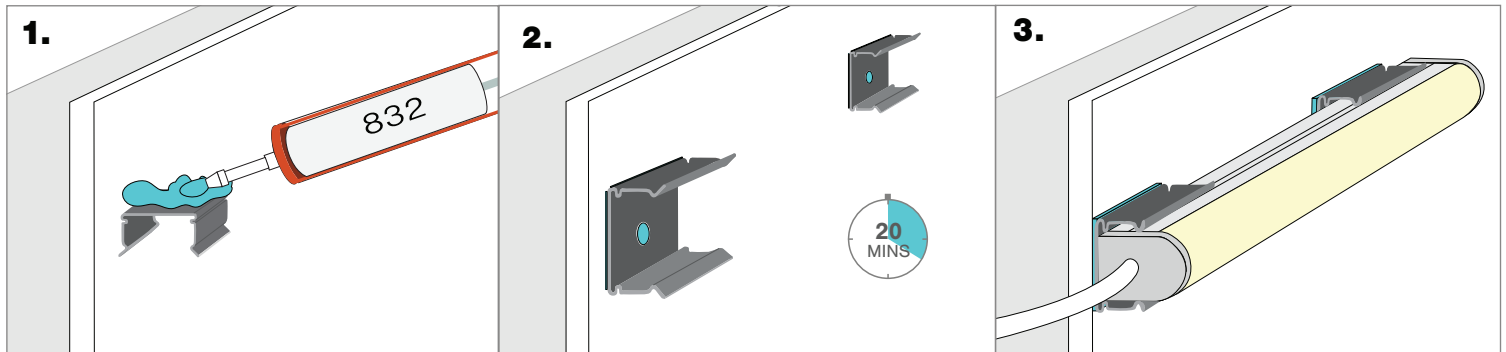

NOTE: 832 Silicone use in a well-ventilated area, 832 Silicone sold with Caulking gun. Do not use in any submersible applications.

VHB Mounting

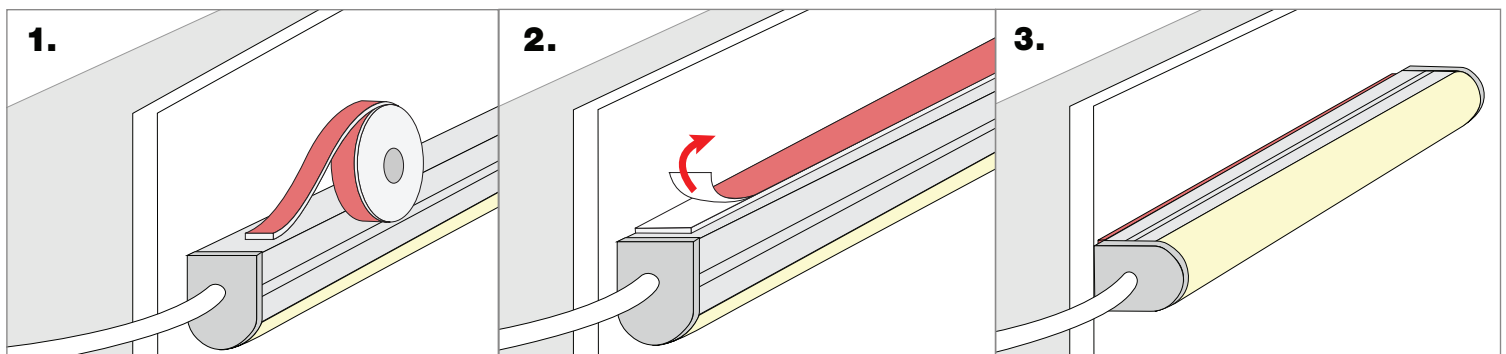

NOTES: • Field modifications must comply with Q-Tran's installation methods otherwise warranty is null and void