

KURV-SW FIXTURES - FLEXIBLE (Q-CAP)



PRODUCT	MOUNTING	RATED	CCT	OUTPUT	LENS	TYPE	CONNECTOR/ WIRE IN	CONNECTOR/ WIRE OUT	END CAPS (NO FEED)	LENGTH (IN)
KURV-SW	WSC RLC MC *SGC PPS-2 PPS-96 PPS-FT PPS-LP-2 PPS-LP-96 PPS-LP-FT	DRY WET	24 - 2400K 27 - 2700K 30 - 3000K 35 - 3500K 40 - 4000K	SO HO VHO	ENC/CL ENC/TL	Single (Closed exit) S1 S2 S3 S4 2S5 2S6 Pass through P1 P2 P3 P4 2P5	1BW BRL	N/A 1BW BRL	CL WH N/A	1" increments from 1"-191"

Voltage: 24 VDC
Wattage: see table

*White snug clip included with side graze channel

ENCAPSULATED PRODUCTS ARE NOT FIELD CUTTABLE

- NOTES:**
- Field modifications are not covered under Q-Tran warranty
 - Data subject to change, all data has +/- 5% tolerance
 - PPS-FT** is to be cut at Q-Tran to requested length
 - 1** BW comes in standard 24"- request custom length (Max 120") by writing it in inches next to "BW" in the order code box (ex. BW48)
 - 2** Connector/Wire In or Out not needed to specify product. Standard configuration is type S1, Connector/Wire In: BW & Connector/Wire Out: N/A with white endcap (WH)
 - 2** PPS mounting clip recommended for seamless applications

OUTPUT Tested for KURV-SW-WSC-DRY [L70 = 40000 HRS]

CCT	SO Standard Output 1.5 W/ft				HO High Output 3.0 W/ft				VHO Very High Output 5.0 W/ft			
	ENC/CL		ENC/TL		ENC/CL		ENC/TL		ENC/CL		ENC/TL	
	LM	CRI	LM	CRI	LM	CRI	LM	CRI	LM	CRI	LM	CRI
2400K	110	94	103	95	197	93	182	93	274	94	261	94
2700K	110	98	103	97	208	98	195	98	279	99	247	99
3000K	118	98	109	98	213	98	198	98	298	97	277	97
3500K	121	96	115	95	213	96	203	97	305	97	295	97
4000K	128	96	121	96	229	97	213	97	294	97	284	97

LENS with LED visibility

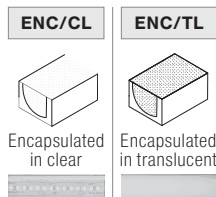

CONNECTOR/WIRE IN

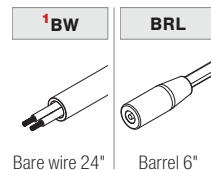

CONNECTOR/WIRE OUT

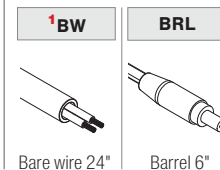

MOUNTING NOTE: 2 white snug clips provided per first 12", 1 for each additional 12". Other mounting styles incur additional charge, see price guide for details.

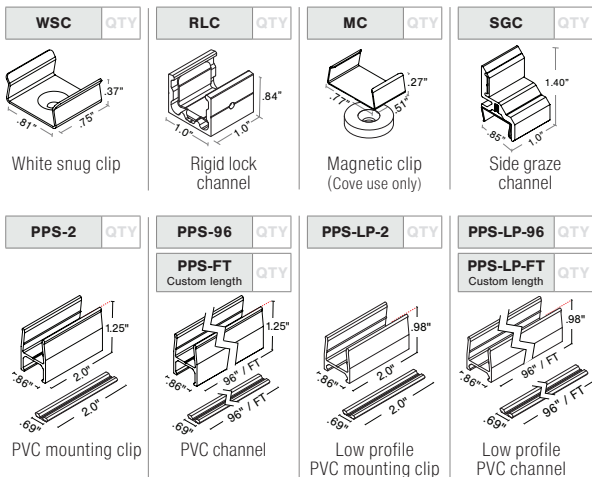

TYPE

SINGLE (Input only)

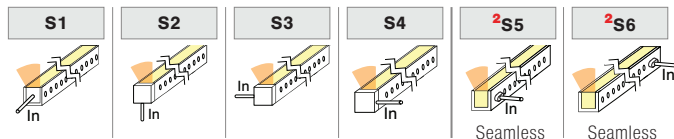

PASS THROUGH (Input/Output)

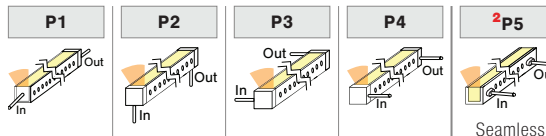

ORDER EXAMPLE

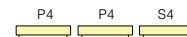

DIMENSIONS

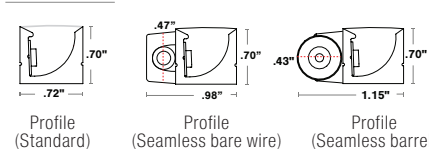

VIEWING ANGLE

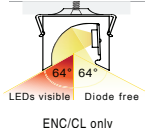

FLEXIBILITY

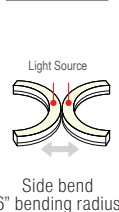

SEAMLESS

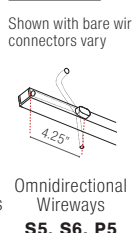

END CAPS (NO FEED)

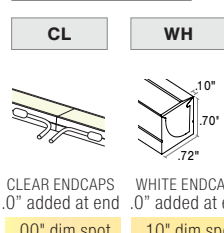

END CAPS (WITH FEED)

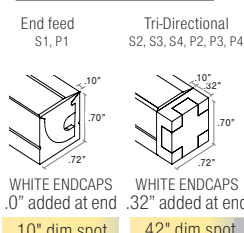

PROJECT NAME	DATE	COMPANY	TYPE	NOTE