

RESOURCE GUIDE - MOUNTING FIXTURES - FLEXIBLE - BOXA-DW



MOUNTING NOTE: 2 white snug clips provided per first 12", 1 for each additional 12". Other mounting styles incur additional charge, see price guide for details.

WSC: WHITE SNUG CLIP

- For indoor/outdoor use
- Surface mounting
- Stainless steel/corrosion resistant
- Discrete mounting
- White glossy finish

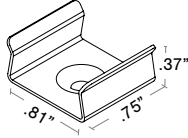

MOUNTING HARDWARE

- #6 flat screw (one provided for each clip)
- 832 Silicone (sold separately)

RLC: RIGID LOCK CHANNEL

- For indoor/outdoor use
- Heavy duty surface mounting
- Stainless steel/corrosion resistant
- Vandal resistant
- Retainer clip provided
- White glossy finish

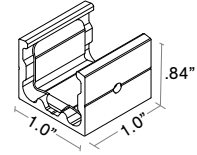

MOUNTING HARDWARE

- #6 flat screw (one provided for each clip)
- 832 Silicone (sold separately)
- 5/64 Allen Key

MC: MAGNETIC CLIP

- For indoor/outdoor use
- Steel clip
- Neodymium magnet
- Easy install
- Easily detachable
- For inaccessible locations such as cove area
- White glossy finish

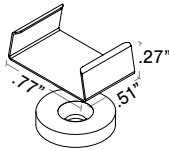

MOUNTING HARDWARE

- #6 flat screw (one provided for each clip)
- 832 Silicone (sold separately)

SGC: SIDE GRAZE CHANNEL

- For indoor/outdoor use
- Surface mounting
- Stainless steel/corrosion resistant
- For wall grazing
- Concealed, no visible hardware
- White glossy finish

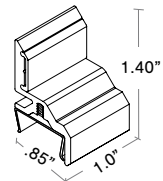

MOUNTING HARDWARE

- #6 flat screw (one provided for each clip)
- 832 Silicone (sold separately)

PPS-2: PVC MOUNT CLIP

- For indoor/outdoor use
- Surface mounting
- For joining seamless fixtures
- Wire way feature
- Off white finish
- Can be mounted with or without PPS-BRACKET (COVE FRIENDLY)

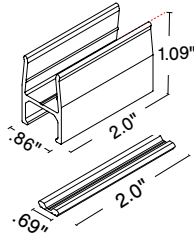

MOUNTING HARDWARE

- #8 flat head screw (1 screw for every 16")
- 832 Silicone (sold separately)

Built in wireway:
The PPS-BRACKET allows you to create a wire way under the PPS channel without any screws interfering

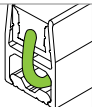

PPS-96 & PPS-FT: PVC MOUNT CHANNEL

- 96" (PPS-96) or custom length (PPS-FT)
- For indoor/outdoor use
- Surface mounting
- Field modifications made easy
- Wire way feature
- Off white finish
- Can be mounted with or without PPS-BRACKET (COVE FRIENDLY)

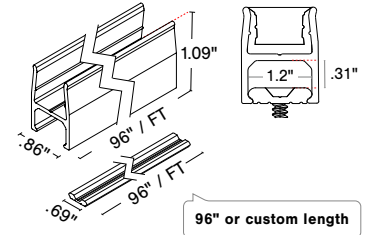

MOUNTING HARDWARE

- #8 flat head screw (1 screw for every 16")
- 832 Silicone (sold separately)

Built in wireway:
The PPS-BRACKET allows you to create a wire way under the PPS channel without any screws interfering



PPS-LP-2: PVC LOW PROFILE MOUNT CLIP

- For indoor/outdoor use
- Surface mounting
- For joining seamless fixtures
- No wire way
- Off white finish
- Can be mounted with or without PPS-BRACKET (COVE FRIENDLY)

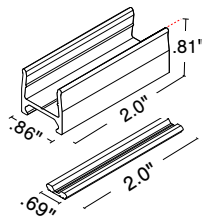

MOUNTING HARDWARE

- #8 Flat head screw (1 screw for every 16")
- 832 Silicone (sold separately)

No wireway

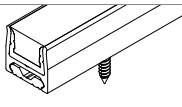

PPS-LP-96 & PPS-LP-FT: PVC LOW PROFILE MOUNT CHANNEL

- 96" (PPS-LP-96) or custom length (PPS-LP-FT)
- For indoor/outdoor use
- Surface mounting
- Low profile mounting
- No wire way
- Off white finish
- Can be mounted with or without PPS-BRACKET (COVE FRIENDLY)

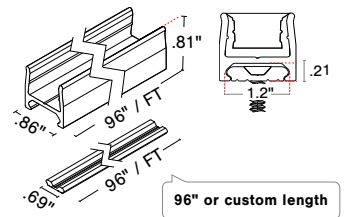

MOUNTING HARDWARE

- #8 Flat head screw (1 screw for every 16")
- 832 Silicone (sold separately)

No wireway

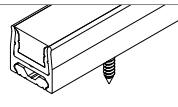

RESOURCE GUIDE - MOUNTING FIXTURES - FLEXIBLE - BOXA-DW



MOUNTING ACCESSORIES

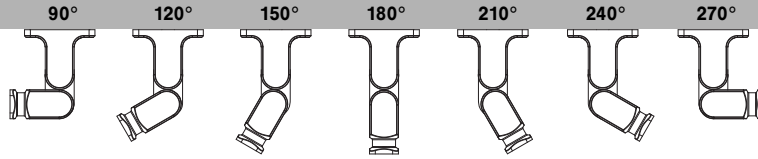

Q-ANGLE

(Full ordering guide and installation available for this product in the [accessories](#) section of website)

- Offset lighting to illuminate signs, artwork, etc.
- For indoor/outdoor use
- Wall, ceiling, or floor mounted
- Stainless steel/corrosion resistant
- Free moving rotating head which can be locked into specific angles
- Preset dial notches for easy adjustments from 90° to 270°

90° BACK VIEW

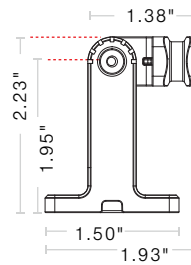

180° BACK VIEW

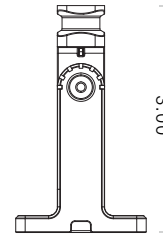

BASE; BOTTOM VIEW

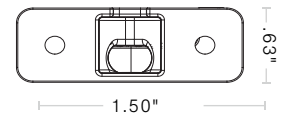

MOUNTING HARDWARE

- Rigid lock channel
- 6-32 Fillister head screw
- 4-40 Flat head screw
- Drywall anchor (not provided)
- #6- 1 1/4 " wood screw

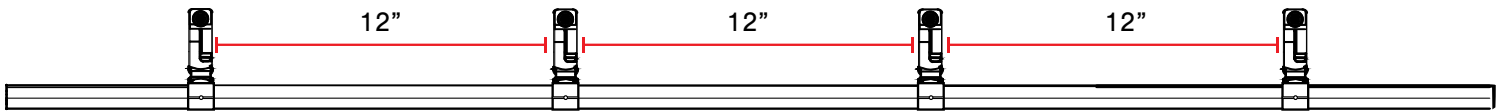

Q-ANGLE MUST BE MOUNTED EVERY 12"

SEE [RIGID LOCK CHANNEL INSTALL](#) AND [Q-ANGLE INSTALL](#) FOR MORE INFORMATION

RIGID LOCK CHANNEL

- For indoor/outdoor use
- Heavy duty surface mounting
- Stainless steel/corrosion resistant
- Vandal resistant
- Retainer clip provided
- White glossy finish

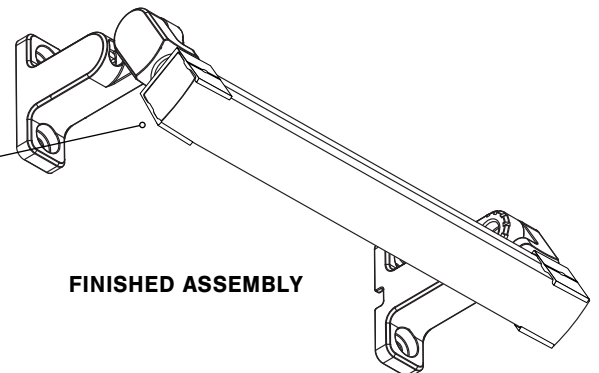
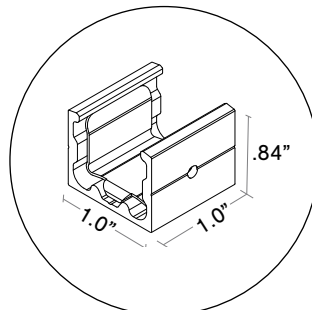

RESOURCE GUIDE - LINEAR FIXTURES - FLEXIBLE - BOXA-DW



RATED

DRY

- Lengths up to 191"
- Encapsulated in polyurethane
- NOT FIELD CUTTABLE

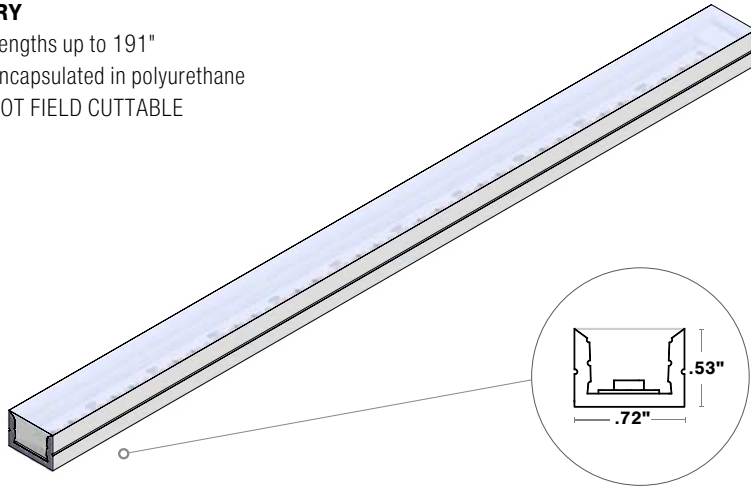

COMPATIBLE CONNECTORS

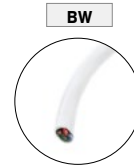

BARE WIRE 24"

WET

- Lengths up to 191"
- Encapsulated in polyurethane
- NOT FIELD CUTTABLE

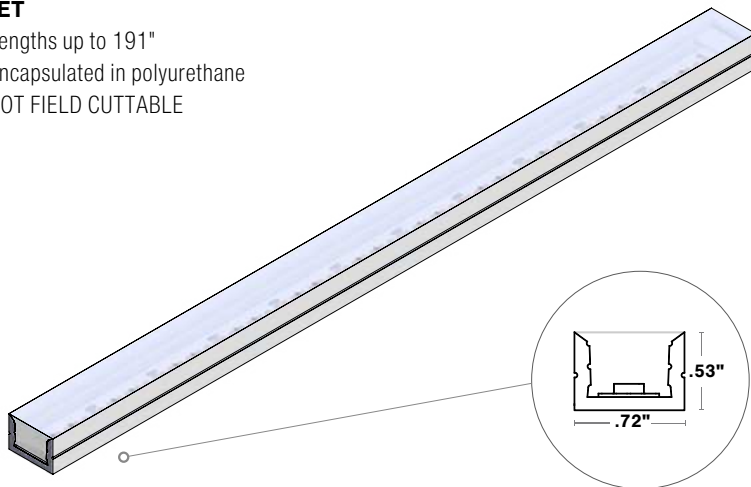

COMPATIBLE CONNECTORS



BARE WIRE 24"

RESOURCE GUIDE - COLOR DATA

FIXTURES - FLEXIBLE - BOXA-DW



2400K: ENC/CL

2387 K

CRI: 92.0
 CRI R9: 62.8
 TM30 Rf: 88.9
 TM30 Rg: 102.4
 CQS: 86.5
 X: 0.488
 Y: 0.415
 U: 0.279
 V: 0.356
 Δuv: 0.0002

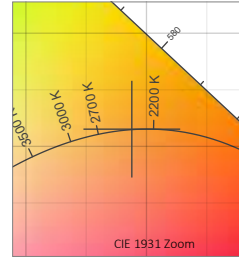
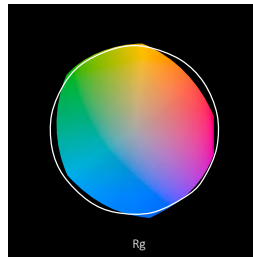
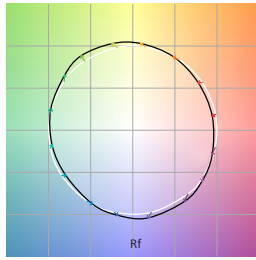

R1	R2	R3	R4	R5	R6	R7	R8	R9	R10	R11	R12	R13	R14	R15	
93.0	94.7	93.6	93.2	91.6	93.5	93.1	83.4	62.8	85.5	93.7	80.5	93.4	94.9	89.1	
Q1	Q2	Q3	Q4	Q5	Q6	Q7	Q8	Q9	Q10	Q11	Q12	Q13	Q14	Q15	
83.9	92.9	84.7	85.9	86.6	83.2	82.1	86.9	93.8	89.1	89.6	90.1	90.4	85.0	84.2	
C1	C2	C3	C4	C5	C6	C7	C8	C9	C10	C11	C12	C13	C14	C15	C16
90.1	90.5	83.1	88.2	90.3	88.6	87.2	90.7	92.3	90.9	88.3	86.5	89.9	84.7	90.1	86.5

TM30			
Hue Bin	R _f	Chroma	Hue
1	90	-4%	-1%
2	90	-4%	3%
3	83	-1%	7%
4	88	3%	6%
5	90	6%	5%
6	89	8%	0%
7	87	4%	-6%
8	91	0%	-6%
9	92	-3%	-3%
10	91	-4%	2%
11	88	-1%	7%
12	86	3%	5%
13	90	6%	-5%
14	85	5%	-8%
15	90	2%	-6%
16	87	-2%	-9%

3000K: ENC/CL

3127 K

CRI: 95.8
 CRI R9: 89.5
 TM30 Rf: 92.2
 TM30 Rg: 102.2
 CQS: 92.4
 X: 0.427
 Y: 0.398
 U: 0.247
 V: 0.345
 Δuv: -0.0011

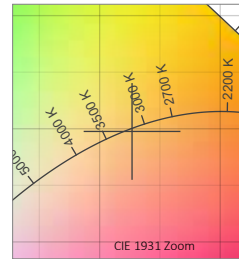
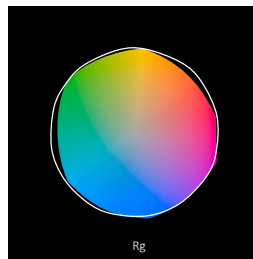
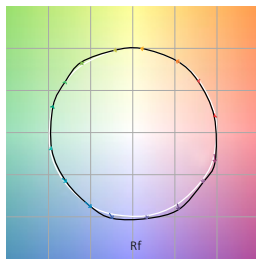

R1	R2	R3	R4	R5	R6	R7	R8	R9	R10	R11	R12	R13	R14	R15	
97.2	96.4	93.1	96.2	95.8	93.8	97.4	96.2	89.5	89.6	95.4	78.2	96.9	95.2	97.2	
Q1	Q2	Q3	Q4	Q5	Q6	Q7	Q8	Q9	Q10	Q11	Q12	Q13	Q14	Q15	
96.1	97.8	86.2	87.6	92.3	92.3	90.0	94.0	95.5	92.9	93.2	94.5	96.0	95.6	95.6	
C1	C2	C3	C4	C5	C6	C7	C8	C9	C10	C11	C12	C13	C14	C15	C16
95.6	95.9	90.9	93.1	92.1	93.8	94.3	96.3	95.0	88.0	85.1	89.0	94.5	91.2	92.7	88.2

TM30			
Hue Bin	R _f	Chroma	Hue
1	96	-1%	-1%
2	96	-1%	1%
3	91	0%	4%
4	93	0%	3%
5	92	0%	3%
6	94	4%	0%
7	94	0%	-1%
8	96	0%	-2%
9	95	-2%	2%
10	88	-2%	6%
11	85	1%	9%
12	89	5%	5%
13	95	3%	1%
14	91	6%	-2%
15	93	2%	-3%
16	88	3%	-8%

2400K: ENC/TL

2369 K

CRI: 92.6
 CRI R9: 64.7
 TM30 Rf: 88.5
 TM30 Rg: 103.2
 CQS: 85.9
 X: 0.487
 Y: 0.411
 U: 0.280
 V: 0.354
 Δuv: -0.0013

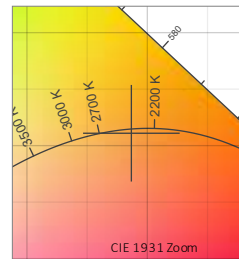
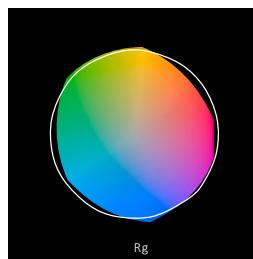
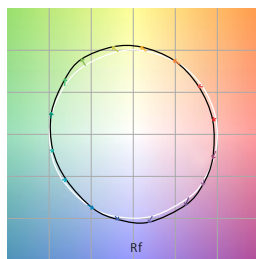

R1	R2	R3	R4	R5	R6	R7	R8	R9	R10	R11	R12	R13	R14	R15	
93.7	95.6	94.6	93.2	92.5	94.7	92.5	83.7	64.7	87.4	93.5	83.3	94.2	95.4	90.1	
Q1	Q2	Q3	Q4	Q5	Q6	Q7	Q8	Q9	Q10	Q11	Q12	Q13	Q14	Q15	
83.6	92.6	84.1	85.3	87.0	83.4	80.0	84.7	93.9	88.2	88.1	88.2	89.0	85.8	84.5	
C1	C2	C3	C4	C5	C6	C7	C8	C9	C10	C11	C12	C13	C14	C15	C16
90.5	90.2	81.6	87.4	89.4	87.4	86.2	89.4	92.7	91.1	88.3	86.5	89.5	84.6	89.9	86.9

TM30			
Hue Bin	R _f	Chroma	Hue
1	91	-4%	-1%
2	90	-4%	3%
3	82	0%	8%
4	87	4%	7%
5	89	7%	5%
6	87	9%	0%
7	86	4%	-7%
8	89	0%	-6%
9	93	-2%	-3%
10	91	-4%	3%
11	88	0%	7%
12	86	3%	5%
13	89	6%	-5%
14	85	5%	-8%
15	90	2%	-6%
16	87	-2%	-9%

- NOTES:**
- CRI R values, only R1-R8 are used to calculate RA CRI values
 - TM30 C values, 16 binned values out of total of 99 C values
 - CQS Q values
 - Data subject to change, all data has +/- 5% tolerance

RESOURCE GUIDE - COLOR DATA

FIXTURES - FLEXIBLE - BOXA-DW



3000K: ENC/TL

3042 K

CRI: 95.6
CRI R9: 89.2
TM30 Rf: 92.1
TM30 Rg: 102.3
CQS: 92.2
X: 0.433
Y: 0.400
U: 0.250
V: 0.346
 $\Delta u v$: -0.0011

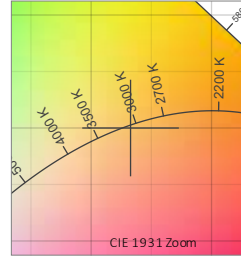
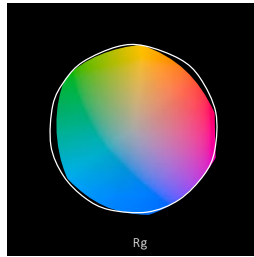
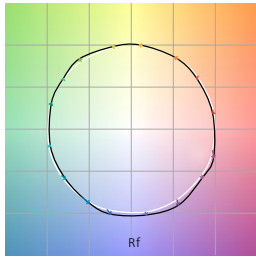

R1	R2	R3	R4	R5	R6	R7	R8	R9	R10	R11	R12	R13	R14	R15	
97.2	96.2	92.6	96.2	95.7	93.7	97.2	96.1	89.2	89.1	95.4	78.5	96.9	94.9	97.1	
Q1	Q2	Q3	Q4	Q5	Q6	Q7	Q8	Q9	Q10	Q11	Q12	Q13	Q14	Q15	
95.7	97.6	86.1	87.6	92.2	91.7	89.2	93.6	95.3	92.6	93.0	94.5	96.0	95.4	95.3	
C1	C2	C3	C4	C5	C6	C7	C8	C9	C10	C11	C12	C13	C14	C16	
95.5	95.8	90.5	92.8	92.1	93.2	94.4	95.8	95.2	88.2	85.4	87.6	94.3	91.1	92.6	88.3

TM30			
Hue Bin	R _f	Chroma	Hue
1	96	-1%	-1%
2	96	-1%	1%
3	91	0%	4%
4	93	0%	3%
5	92	0%	3%
6	93	4%	0%
7	94	1%	-2%
8	96	0%	-2%
9	95	-2%	1%
10	88	-2%	6%
11	85	1%	10%
12	88	4%	5%
13	94	4%	1%
14	91	6%	-2%
15	93	2%	-3%
16	88	3%	-8%

NOTES:

- CRI R values, only R1-R8 are used to calculate RA CRI values
- TM30 C values, 16 binned values out of total of 99 C values
- CQS Q values
- Data subject to change, all data has +/- 5% tolerance

RESOURCE GUIDE - FLEXIBLE FIXTURES

FIXTURES - FLEXIBLE - BOXA-DW



LENS



ENC/CL Encapsulated in Clear

ENC/TL Encapsulated in Translucent

LIGHT ORIENTATION

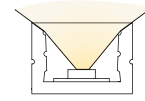

CONNECTORS

BW



BARE WIRE 24"

TYPE

S1 - Input only

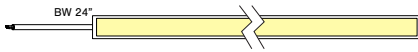

P1 - Input/Output

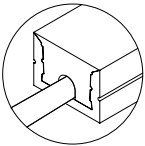
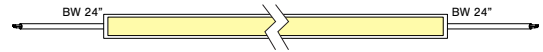

.0" added at end

S2 - Input only

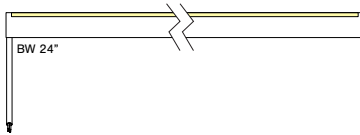

P2 - Input/Output

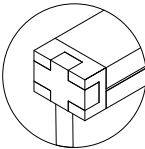
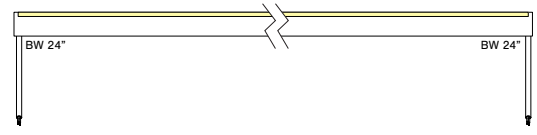

.32" added at end

S3 - Input only

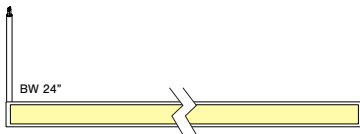

P3 - Input/Output

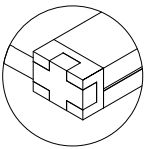
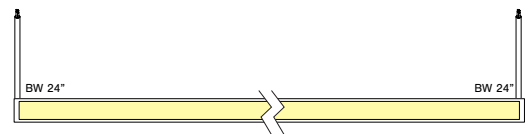

.32" added at end

S4 - Input only

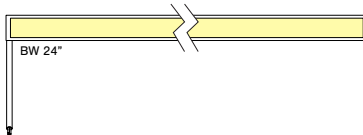

P4 - Input/Output

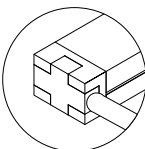
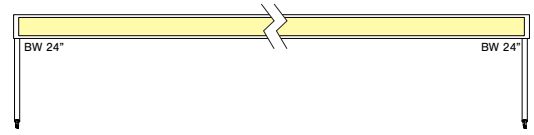

.32" added at end

RESOURCE GUIDE - FLEXIBLE FIXTURES

FIXTURES - FLEXIBLE - BOXA-DW



SEAMLESS

Order the **PPS-2** to join two fixtures together with no visible break and order the **PPS-96/PPS-FT** or to support the fixtures, All seamless fixtures have CLEAR endcaps

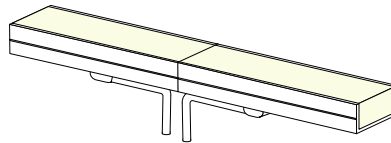
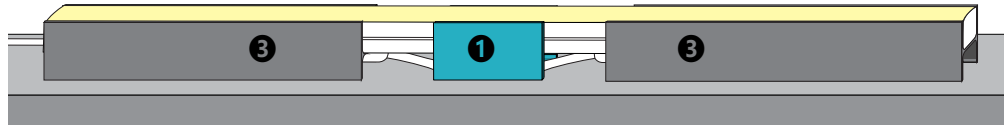
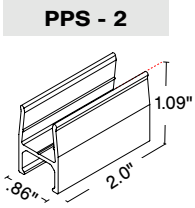

SEAMLESS WITH BARE WIRE

SEAMLESS

Order the **PPS-LP-2** to support two fixtures together with no visible break and order the **PPS-LP-96/PPS-LP-FT** to support the fixture

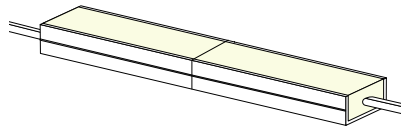
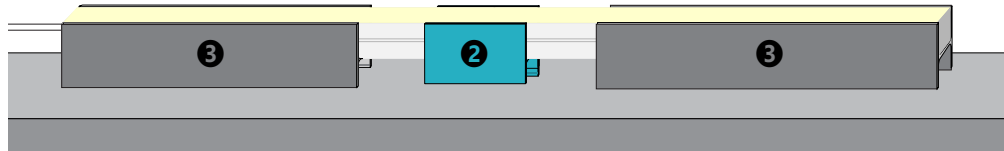
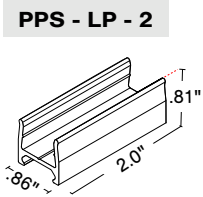

FIXTURE WITH BARE WIRE

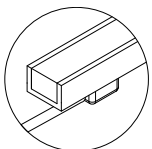

.00" added at end
.40" added to fixture height

S5 - Input only



P5 - Input/Output

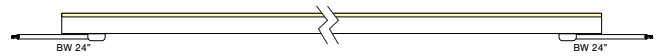

- 1** = PPS - 2
- 2** = PPS - LP - 2
- 3** = PPS - 96/PPS - FT or PPS - LP - 96/PPS - LP - FT

RESOURCE GUIDE - CONNECTORS/WIRE FIXTURES - FLEXIBLE - BOXA-DW



CONNECTORS/WIRE

BARE WIRE

- Belden wire 22 AWG
- Outdoor rated
- 24" Standard length

BW



BARE WIRE