

Photometric Details



WURM-RGB-WSC-DRY-ALL-SO-ENC-CL-S1-BW-NA

Product name:	WURM-RGB-WSC-DRY-ALL-SO-ENC-CL-S1-BW-NA
Date:	9/27/2019
Powering product:	IQ-PH-80-120/24
Output:	210 lm/ft
Peak:	65.8 cd
Power:	5.3 W/ft
PF:	1.0



Beam Angle

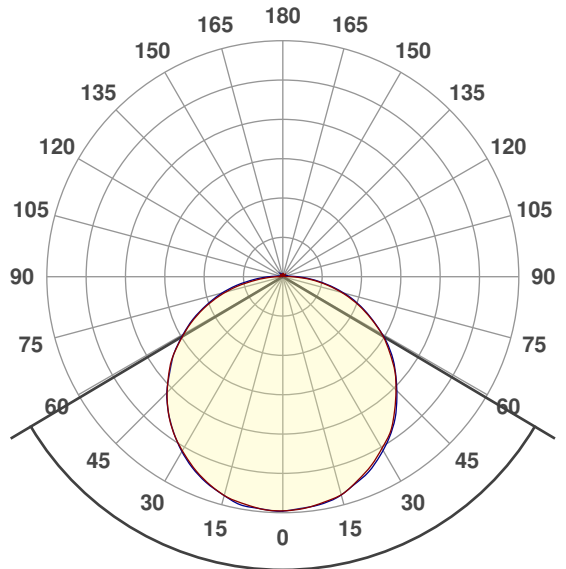

118.5°

CIE 1931
x: 0.275
y: 0.336

Light efficiency:



Light quality:

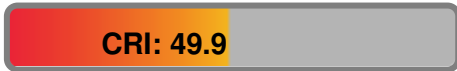

Color temperature:



Spectra

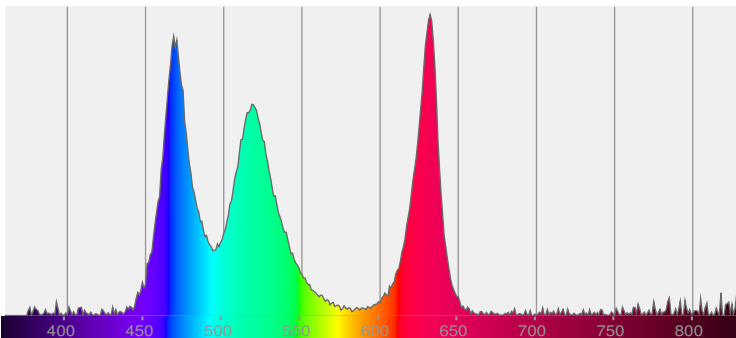

Power

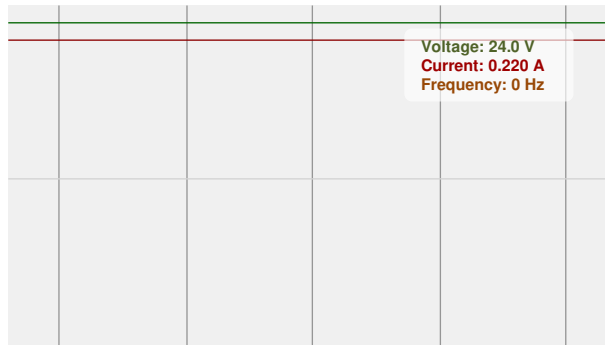

Color Details



WURM-RGB-WSC-DRY-ALL-SO-ENC-CL-S1-BW-NA

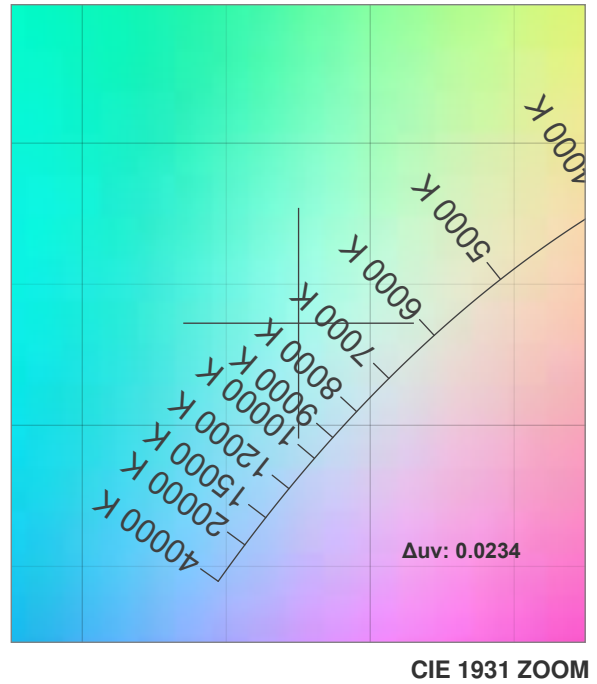
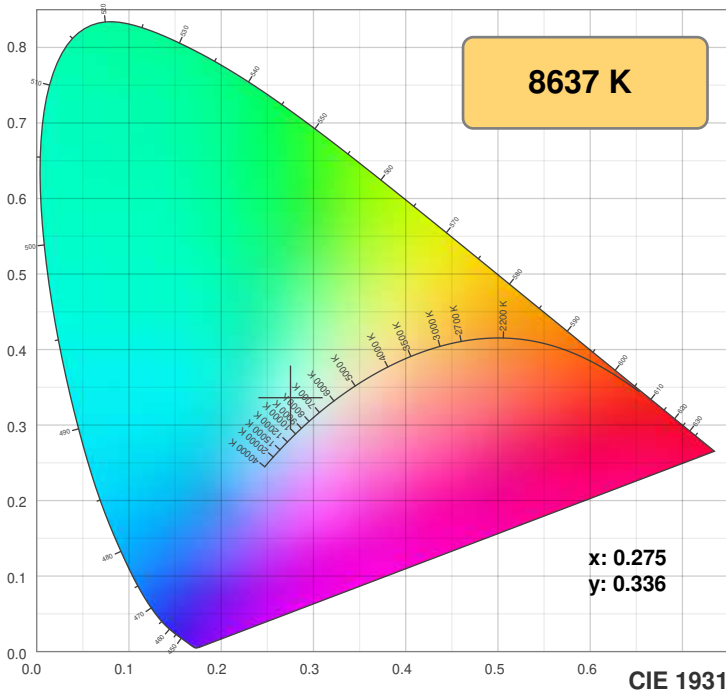

TM30: 48.0

CRI: 49.9 (R1-R8)

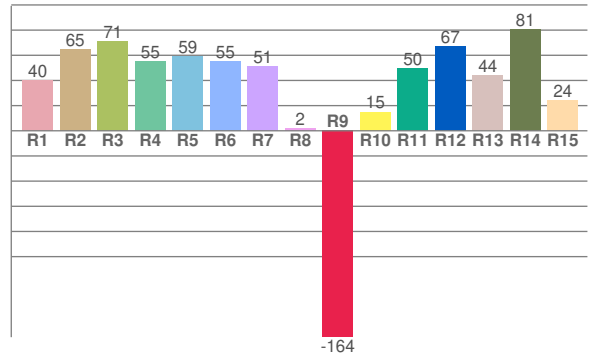
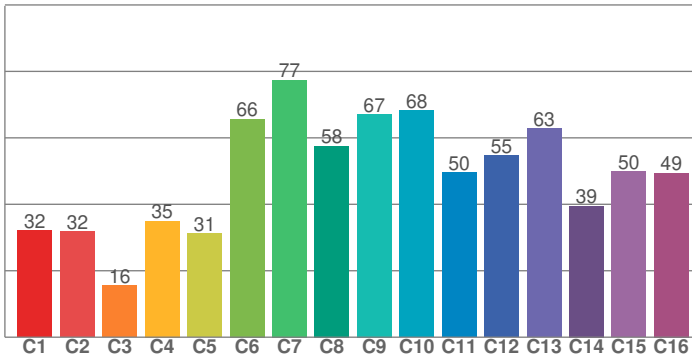

CRI R values, only R1-R8 are used to calculate final CRI value

R1	R2	R3	R4	R5	R6	R7	R8	R9	R10	R11	R12	R13	R14	R15
40.3	64.8	70.9	55.2	58.9	55.2	51.3	2.3	-164.0	15.0	49.7	66.9	43.8	80.9	24.1

TM30 C values, 16 binned values out of total of 99 C values

C1	C2	C3	C4	C5	C6	C7	C8	C9	C10	C11	C12	C13	C14	C15	C16
32.1	31.8	15.5	35.0	31.2	65.7	77.5	57.5	67.1	68.2	49.6	54.8	62.7	39.5	49.9	49.5

CQS Q values

Q1	Q2	Q3	Q4	Q5	Q6	Q7	Q8	Q9	Q10	Q11	Q12	Q13	Q14	Q15
50.7	58.6	53.7	50.1	76.7	85.8	72.8	64.6	53.2	30.1	13.2	12.7	32.4	75.2	57.4

CQS: 47.1

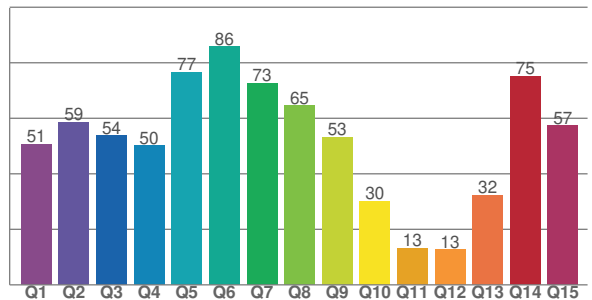

Color parameters

Color temperature	Color rendering index	Red component	Color fidelity	Color gamut	Color quality scale	Color coordinate cie 1931	Color coordinate cie 1931	Color coordinate	Color coordinate	Color deviation from black body
CCT	CRI	CRI R9	TM30 Rf	TM30 Rg	CQS	x	y	u	v	Δuv
8637 K	49.9	-164.0	48.0	94.6	47.1	0.275	0.336	0.170	0.311	0.0234

TM30 Details



WURM-RGB-WSC-DRY-ALL-SO-ENC-CL-S1-BW-NA

Rf 48.0
Fidelity index Rf

Rg 94.6
Gammut index Rg

Hue Bin	R _f	Graphic shifts (%)	
		Chroma	Hue
1	32	33%	6%
2	32	27%	-22%
3	16	10%	-45%
4	35	-14%	-37%
5	31	-35%	-20%
6	66	-15%	12%
7	77	2%	6%
8	58	6%	20%
9	67	18%	9%
10	68	9%	-9%
11	50	2%	-18%
12	55	-15%	-20%
13	63	-18%	3%
14	39	-16%	31%
15	50	14%	36%
16	49	14%	19%

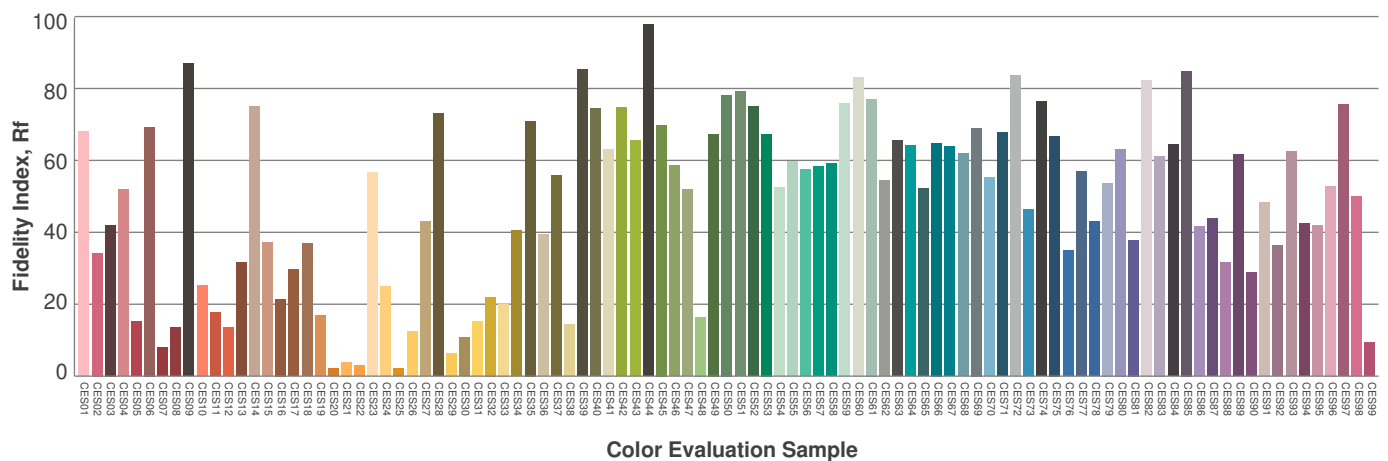
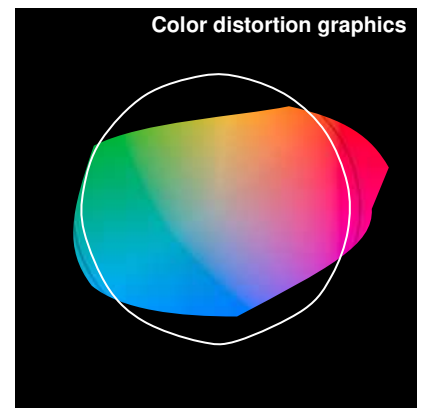
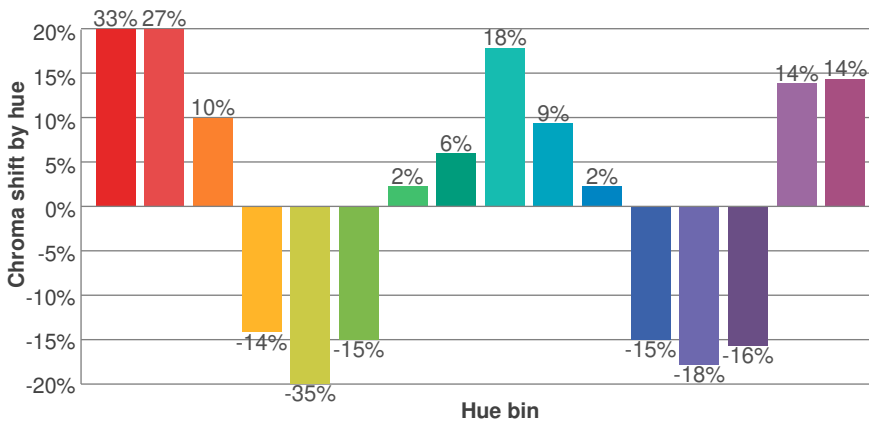
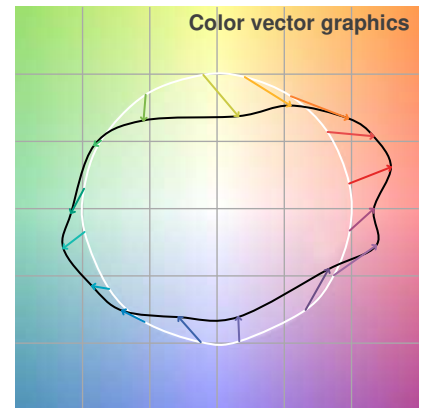
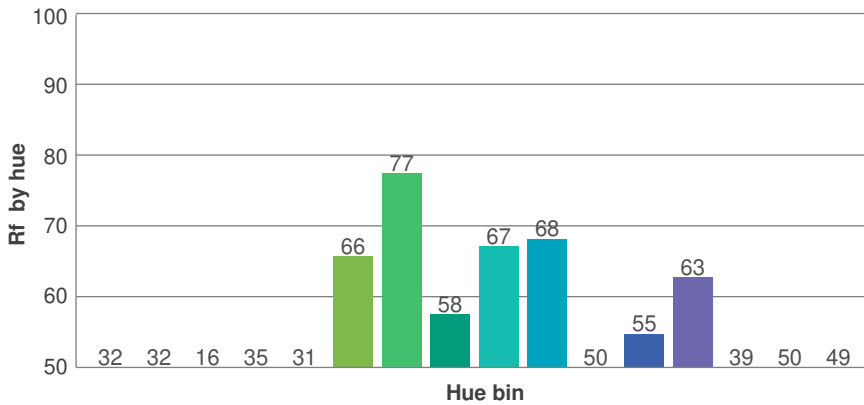
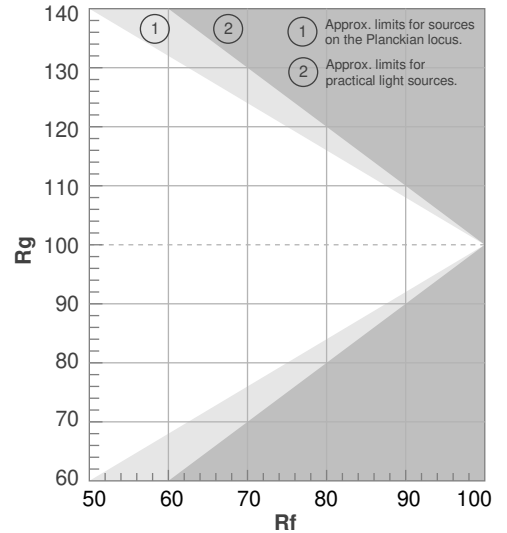

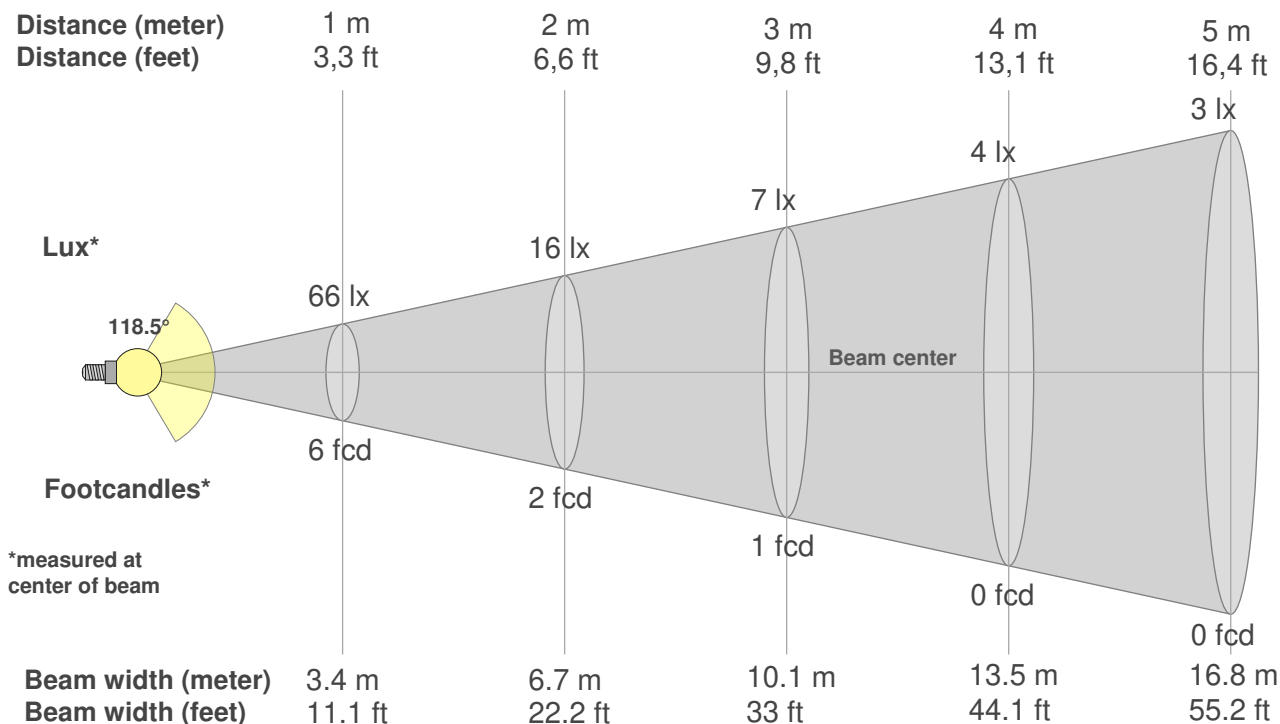

Beam intensities from 1-20m

1m	2m	3m	4m	5m	6m	7m	8m	9m	10m	11m	12m	13m	14m	15m	16m	17m	18m	19m	20m
3.3ft	6.6ft	9.8ft	13.1ft	16.4ft	19.7ft	23ft	26.2ft	29.5ft	32.8ft	36.1ft	39.4ft	42.7ft	45.9ft	49.2ft	52.5ft	55.8ft	59.1ft	62.3ft	65.6ft
66lx	16lx	7lx	4lx	3lx	2lx	1lx	1lx	1lx	1lx	1lx	0lx	0lx	0lx	0lx	0lx	0lx	0lx	0lx	0lx
6.1fcd	1.5fcd	0.7fcd	0.4fcd	0.2fcd	0.2fcd	0.1fcd	0.1fcd	0.1fcd	0.1fcd	0.1fcd	0fcd	0fcd	0fcd	0fcd	0fcd	0fcd	0fcd	0fcd	0fcd

Intensities in 0° c-plane

0°	5°	10°	15°	20°	25°	30°	35°	40°	45°	50°	55°	60°	65°	70°	75°	80°	85°	90°	95°
65.7	65.3	64.4	63.3	61.0	58.6	55.6	52.8	48.8	44.9	41.0	36.5	32.1	27.0	22.1	17.1	12.0	7.1	2.8	0.7
100%	99%	98%	96%	93%	89%	85%	80%	74%	68%	62%	56%	49%	41%	34%	26%	18%	11%	4%	1%

Intensities in 90° c-plane

0°	5°	10°	15°	20°	25°	30°	35°	40°	45°	50°	55°	60°	65°	70°	75°	80°	85°	90°	95°
65.7	65.2	64.6	63.3	61.3	59.1	56.3	53.1	49.4	45.3	41.2	37.0	32.2	27.3	22.6	17.7	12.7	8.1	4.3	1.9
100%	99%	98%	96%	93%	90%	86%	81%	75%	69%	63%	56%	49%	42%	34%	27%	19%	12%	7%	3%

Intensities in 180° c-plane

0°	5°	10°	15°	20°	25°	30°	35°	40°	45°	50°	55°	60°	65°	70°	75°	80°	85°	90°	95°
65.7	65.5	64.6	63.5	61.6	59.2	56.4	53.4	49.9	45.9	41.7	37.1	32.1	27.1	21.9	16.5	10.9	5.7	2.1	0.6
100%	100%	98%	97%	94%	90%	86%	81%	76%	70%	63%	57%	49%	41%	33%	25%	17%	9%	3%	1%

Intensities in 270° c-plane

0°	5°	10°	15°	20°	25°	30°	35°	40°	45°	50°	55°	60°	65°	70°	75°	80°	85°	90°	95°
65.7	65.5	65.1	63.6	61.8	59.5	56.6	53.4	49.9	46.0	41.4	37.2	32.3	27.6	22.5	17.6	12.6	7.7	4.1	1.8
100%	100%	99%	97%	94%	91%	86%	81%	76%	70%	63%	57%	49%	42%	34%	27%	19%	12%	6%	3%

Beam angle 50%	Field angle 10%	Cutoff angle 2,5%	Intensity ratio in 120° cone	Intensity ratio in 90° cone
118.5°	171.4°	187.6°	72.6%	48.5%

Photometric Details



WURM-RGB-WSC-DRY-R-SO-ENC-CL-S1-BW-NA

Product name:	WURM-RGB-WSC-DRY-R-SO-ENC-CL-S1-BW-NA
Date:	9/27/2019
Powering product:	IQ-PH-80-120/24
Output:	54.0 lm/ft
Peak:	16.3 cd
Power:	1.9 W/ft
PF:	1.0



Beam Angle

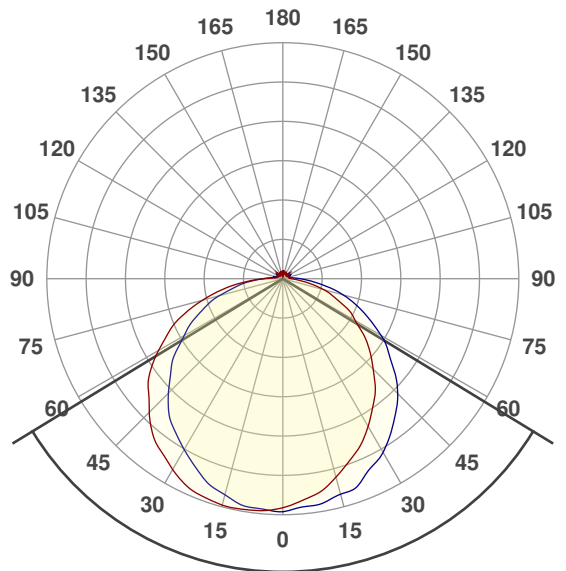

117.3°

CIE 1931
x: 0.665
y: 0.300

Light efficiency:



Light quality:



Color temperature:



Spectra

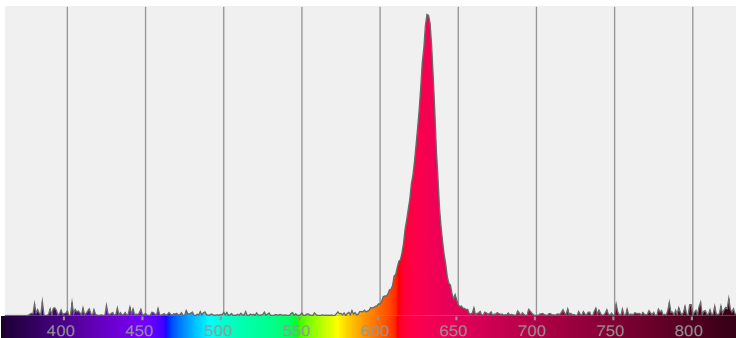

Power

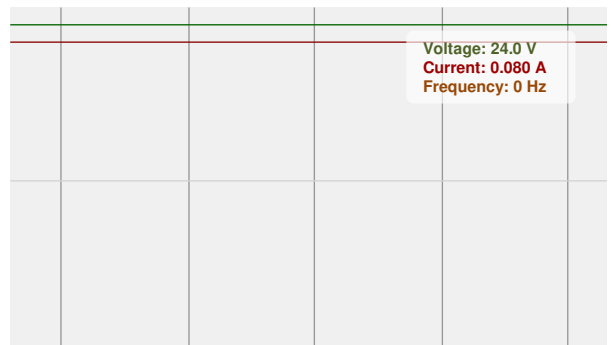

Color Details



WURM-RGB-WSC-DRY-R-SO-ENC-CL-S1-BW-NA

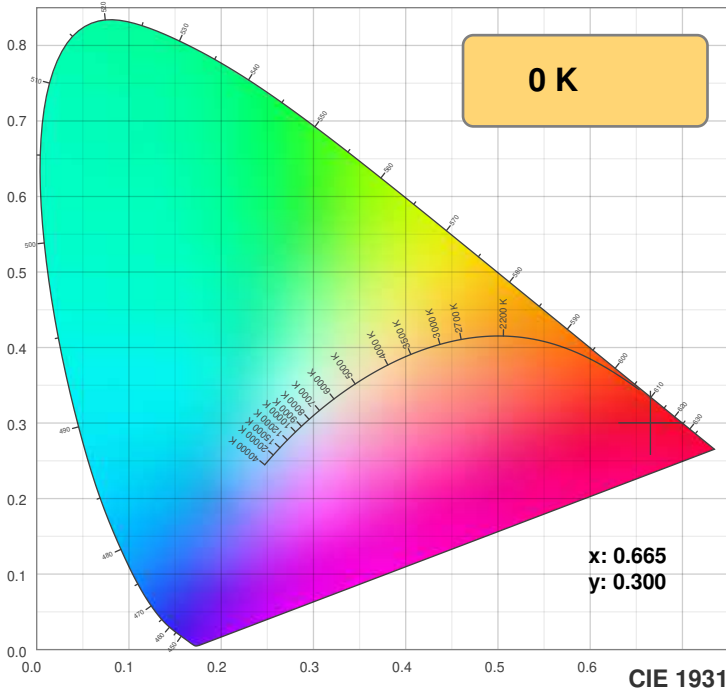

TM30: 0.0

CRI: 0.0 (R1-R8)

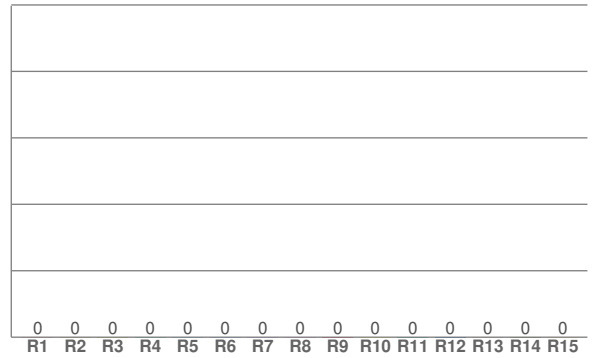
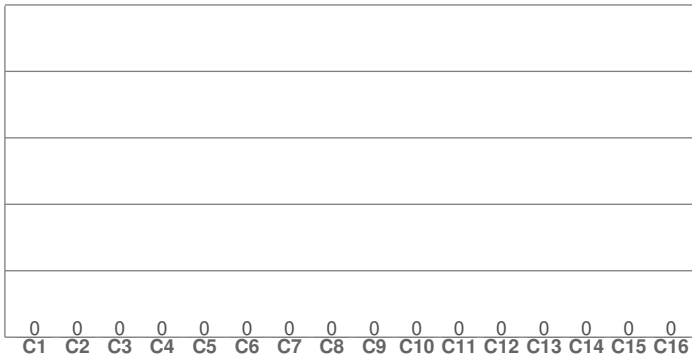

CRI R values, only R1-R8 are used to calculate final CRI value

R1	R2	R3	R4	R5	R6	R7	R8	R9	R10	R11	R12	R13	R14	R15
0.0	0.0	0.0	0.0	0.0	0.0	0.0	0.0	0.0	0.0	0.0	0.0	0.0	0.0	0.0

TM30 C values, 16 binned values out of total of 99 C values

C1	C2	C3	C4	C5	C6	C7	C8	C9	C10	C11	C12	C13	C14	C15	C16
0.0	0.0	0.0	0.0	0.0	0.0	0.0	0.0	0.0	0.0	0.0	0.0	0.0	0.0	0.0	0.0

CQS Q values

Q1	Q2	Q3	Q4	Q5	Q6	Q7	Q8	Q9	Q10	Q11	Q12	Q13	Q14	Q15
0.0	0.0	0.0	0.0	0.0	0.0	0.0	0.0	0.0	0.0	0.0	0.0	0.0	0.0	0.0

CQS: 0.0

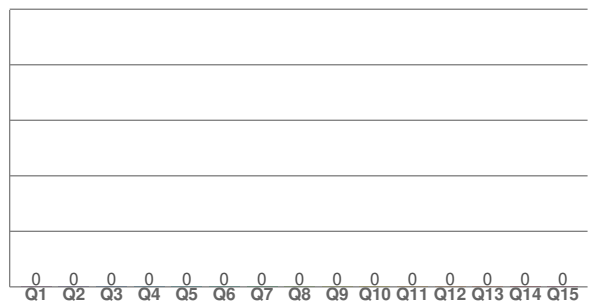

Color parameters

Color temperature	Color rendering index	Red component	Color fidelity	Color gamut	Color quality scale	Color coordinate cie 1931	Color coordinate cie 1931	Color coordinate	Color coordinate	Color deviation from black body
CCT	CRI	CRI R9	TM30 Rf	TM30 Rg	CQS	x	y	u	v	Δuv
0 K	0.0	0.0	0.0	0.0	0.0	0.665	0.300	0.505	0.342	n/a

TM30 Details



WURM-RGB-WSC-DRY-R-SO-ENC-CL-S1-BW-NA

Rf 0.0
Fidelity index Rf

Rg 0.0
Gammut index Rg

Hue Bin	R _f	Graphic shifts (%)	
		Chroma	Hue
1	0	0%	0%
2	0	0%	0%
3	0	0%	0%
4	0	0%	0%
5	0	0%	0%
6	0	0%	0%
7	0	0%	0%
8	0	0%	0%
9	0	0%	0%
10	0	0%	0%
11	0	0%	0%
12	0	0%	0%
13	0	0%	0%
14	0	0%	0%
15	0	0%	0%
16	0	0%	0%

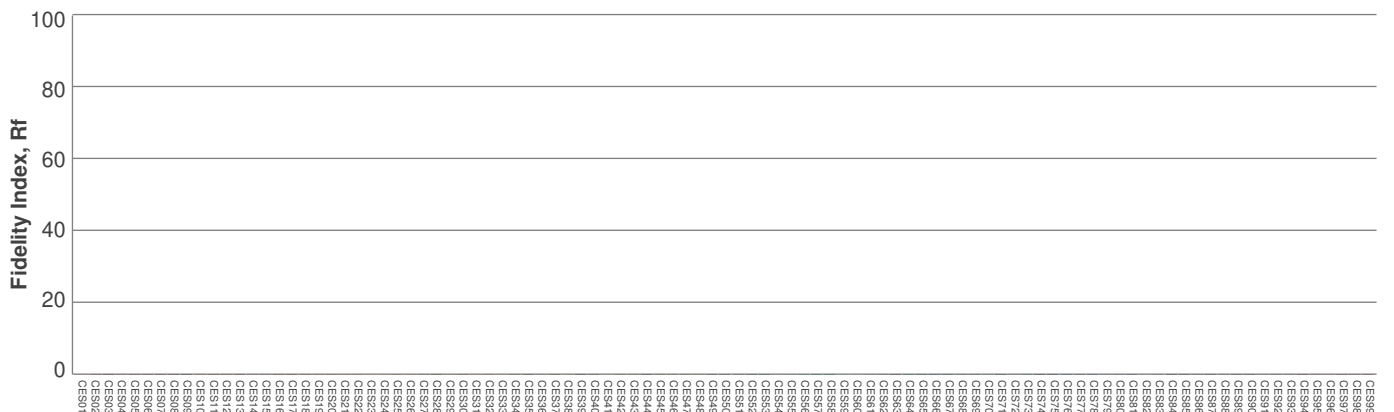
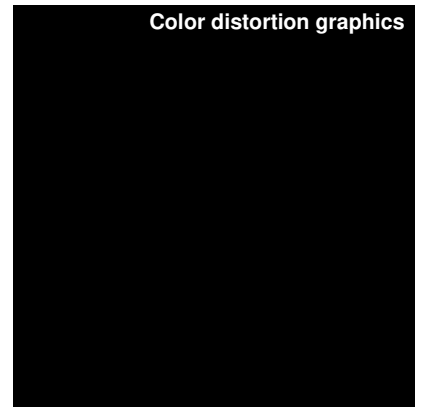
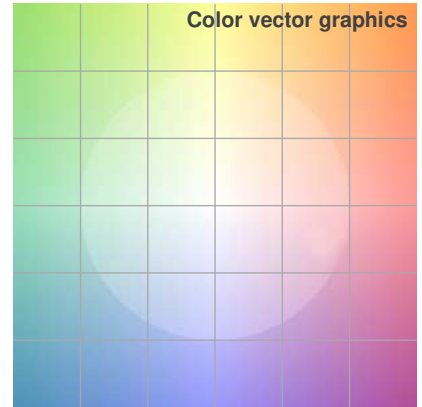
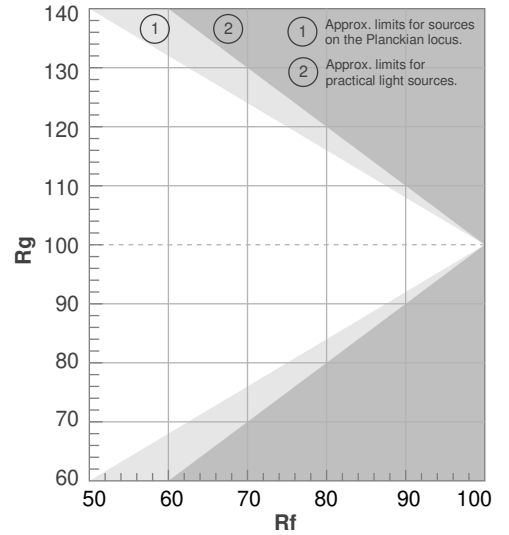

Color Evaluation Sample

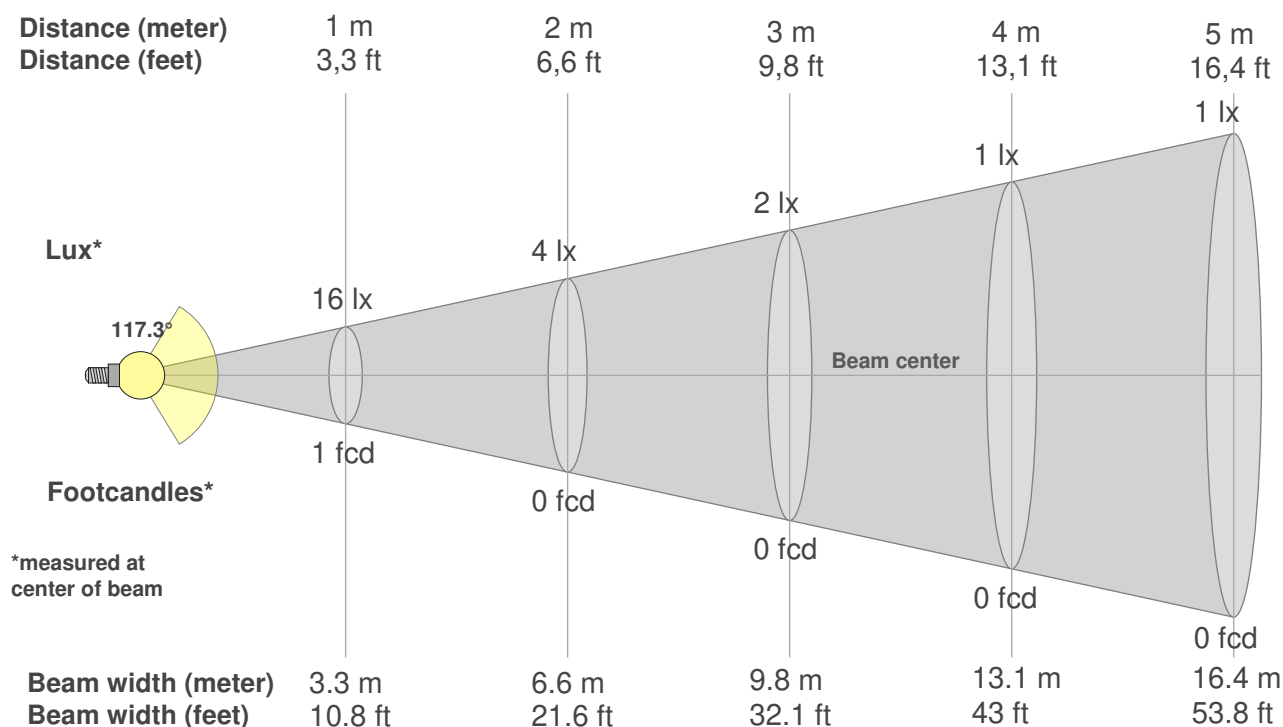

Beam intensities from 1-20m

1m	2m	3m	4m	5m	6m	7m	8m	9m	10m	11m	12m	13m	14m	15m	16m	17m	18m	19m	20m
3.3ft	6.6ft	9.8ft	13.1ft	16.4ft	19.7ft	23ft	26.2ft	29.5ft	32.8ft	36.1ft	39.4ft	42.7ft	45.9ft	49.2ft	52.5ft	55.8ft	59.1ft	62.3ft	65.6ft
16lx	4lx	2lx	1lx	1lx	0lx	0lx	0lx	0lx	0lx	0lx	0lx	0lx	0lx	0lx	0lx	0lx	0lx	0lx	0lx
1.5fcd	0.4fcd	0.2fcd	0.1fcd	0.1fcd	0fcd	0fcd	0fcd	0fcd	0fcd	0fcd	0fcd	0fcd	0fcd	0fcd	0fcd	0fcd	0fcd	0fcd	0fcd

Intensities in 0° c-plane

0°	5°	10°	15°	20°	25°	30°	35°	40°	45°	50°	55°	60°	65°	70°	75°	80°	85°	90°	95°
16.1	15.5	15.0	14.3	13.5	12.8	11.9	10.9	10.0	8.9	7.9	6.9	5.8	5.0	3.9	3.0	1.9	1.1	0.6	0.5
100%	96%	94%	89%	84%	80%	74%	68%	62%	55%	49%	43%	36%	31%	24%	18%	12%	7%	4%	3%

Intensities in 90° c-plane

0°	5°	10°	15°	20°	25°	30°	35°	40°	45°	50°	55°	60°	65°	70°	75°	80°	85°	90°	95°
16.1	15.9	15.8	15.5	15.3	14.5	13.9	13.1	12.2	11.3	10.2	9.0	7.9	6.6	5.5	4.3	3.1	2.0	1.2	0.7
100%	99%	99%	97%	95%	90%	87%	82%	76%	70%	63%	56%	49%	41%	34%	27%	20%	13%	8%	5%

Intensities in 180° c-plane

0°	5°	10°	15°	20°	25°	30°	35°	40°	45°	50°	55°	60°	65°	70°	75°	80°	85°	90°	95°
16.1	16.2	16.3	16.3	16.1	15.9	15.3	14.7	14.1	13.1	12.2	11.2	10.0	8.7	7.4	5.8	4.2	2.7	1.4	0.6
100%	101%	101%	101%	100%	99%	95%	92%	88%	82%	76%	70%	62%	54%	46%	36%	26%	17%	9%	4%

Intensities in 270° c-plane

0°	5°	10°	15°	20°	25°	30°	35°	40°	45°	50°	55°	60°	65°	70°	75°	80°	85°	90°	95°
16.1	16.1	16.0	15.6	15.2	14.4	13.7	13.0	12.3	11.3	10.2	9.2	7.9	6.9	5.7	4.6	3.4	2.4	1.4	0.8
100%	100%	100%	97%	94%	90%	85%	81%	77%	70%	63%	57%	49%	43%	36%	29%	21%	15%	9%	5%

Beam angle 50%	Field angle 10%	Cutoff angle 2,5%	Intensity ratio in 120° cone	Intensity ratio in 90° cone
117.3°	173.2°	355.3°	69.2%	46.2%

Photometric Details



WURM-RGB-WSC-DRY-G-SO-ENC-CL-S1-BW-NA

Product name:	WURM-RGB-WSC-DRY-G-SO-ENC-CL-S1-BW-NA
Date:	9/27/2019
Powering product:	IQ-PH-80-120/24
Output:	147 lm/ft
Peak:	45.0 cd
Power:	2.4 W/ft
PF:	1.0



Beam Angle

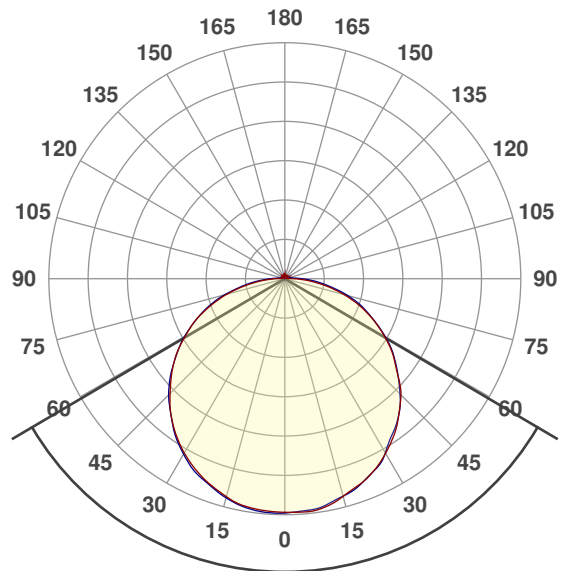

119.1°

CIE 1931
x: 0.158
y: 0.693



Light efficiency:



Light quality:



Color temperature:



Spectra

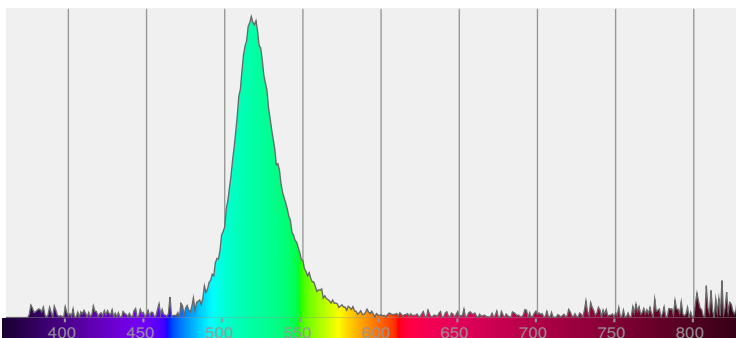

Power

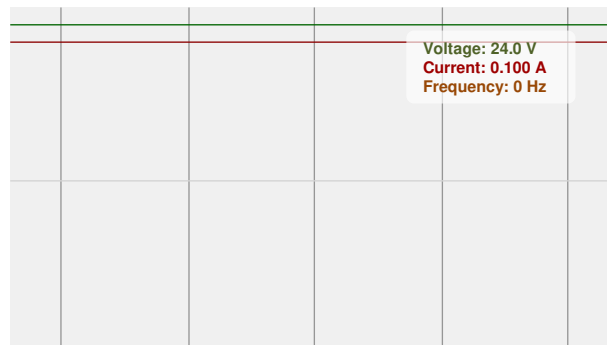

Color Details



WURM-RGB-WSC-DRY-G-SO-ENC-CL-S1-BW-NA

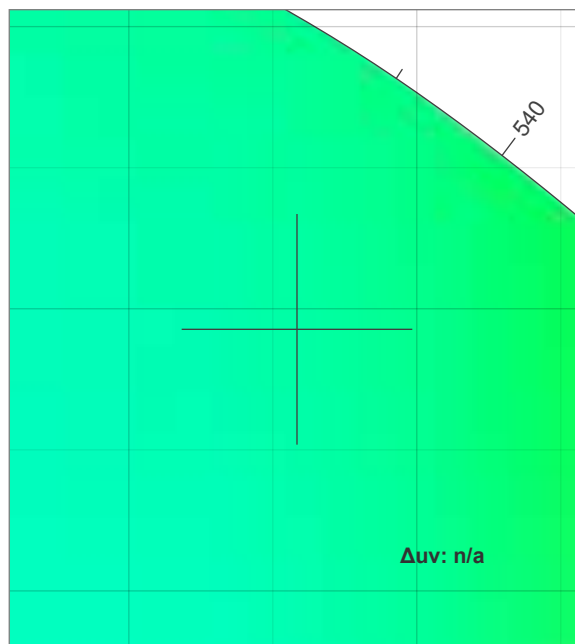
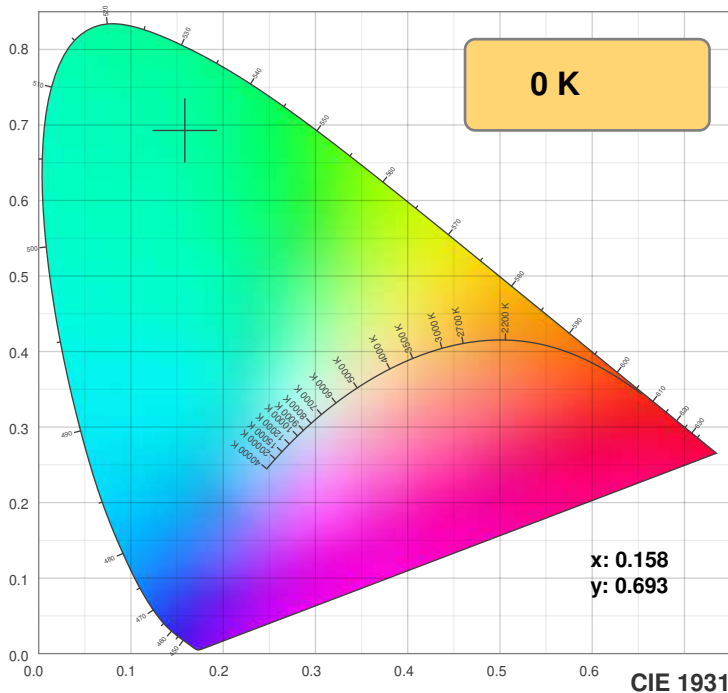

TM30: 0.0

CRI: 0.0 (R1-R8)

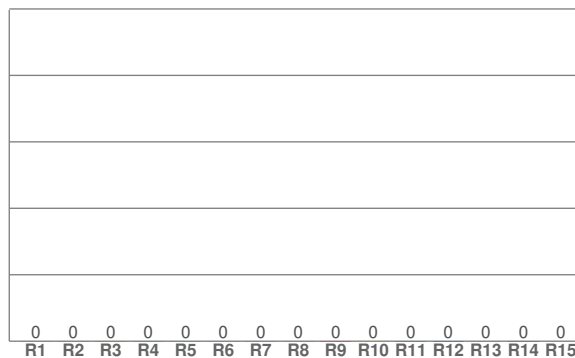
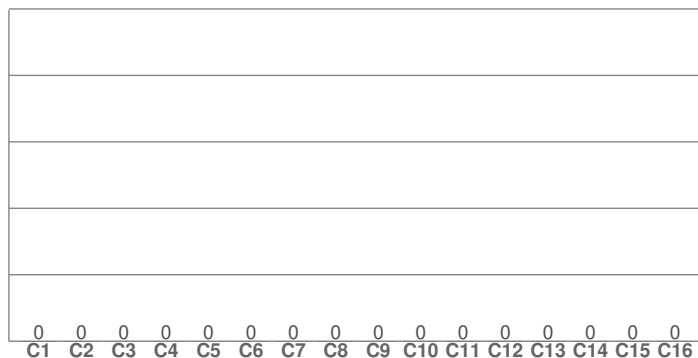

CRI R values, only R1-R8 are used to calculate final CRI value

R1	R2	R3	R4	R5	R6	R7	R8	R9	R10	R11	R12	R13	R14	R15
0.0	0.0	0.0	0.0	0.0	0.0	0.0	0.0	0.0	0.0	0.0	0.0	0.0	0.0	0.0

TM30 C values, 16 binned values out of total of 99 C values

C1	C2	C3	C4	C5	C6	C7	C8	C9	C10	C11	C12	C13	C14	C15	C16
0.0	0.0	0.0	0.0	0.0	0.0	0.0	0.0	0.0	0.0	0.0	0.0	0.0	0.0	0.0	0.0

CQS Q values

Q1	Q2	Q3	Q4	Q5	Q6	Q7	Q8	Q9	Q10	Q11	Q12	Q13	Q14	Q15
0.0	0.0	0.0	0.0	0.0	0.0	0.0	0.0	0.0	0.0	0.0	0.0	0.0	0.0	0.0

CQS: 0.0

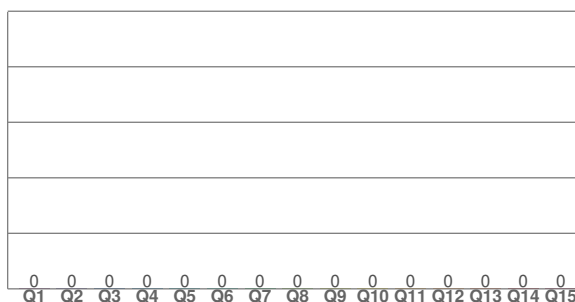

Color parameters

Color temperature	Color rendering index	Red component	Color fidelity	Color gamut	Color quality scale	Color coordinate cie 1931	Color coordinate cie 1931	Color coordinate	Color coordinate	Color deviation from black body
CCT	CRI	CRI R9	TM30 Rf	TM30 Rg	CQS	x	y	u	v	Δuv
0 K	0.0	0.0	0.0	0.0	0.0	0.158	0.693	0.058	0.378	n/a

TM30 Details



WURM-RGB-WSC-DRY-G-SO-ENC-CL-S1-BW-NA

Rf 0.0
Fidelity index Rf

Rg 0.0
Gammut index Rg

Hue Bin	R _f	Graphic shifts (%)	
		Chroma	Hue
1	0	0%	0%
2	0	0%	0%
3	0	0%	0%
4	0	0%	0%
5	0	0%	0%
6	0	0%	0%
7	0	0%	0%
8	0	0%	0%
9	0	0%	0%
10	0	0%	0%
11	0	0%	0%
12	0	0%	0%
13	0	0%	0%
14	0	0%	0%
15	0	0%	0%
16	0	0%	0%

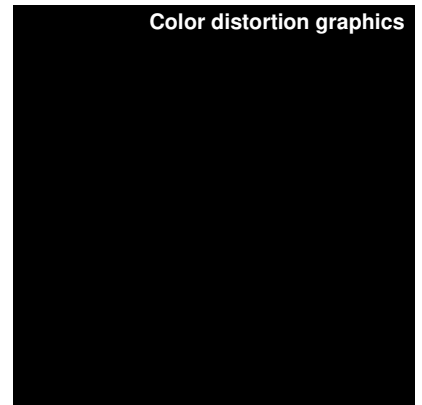
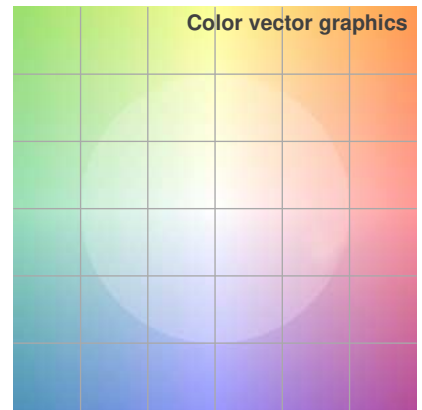
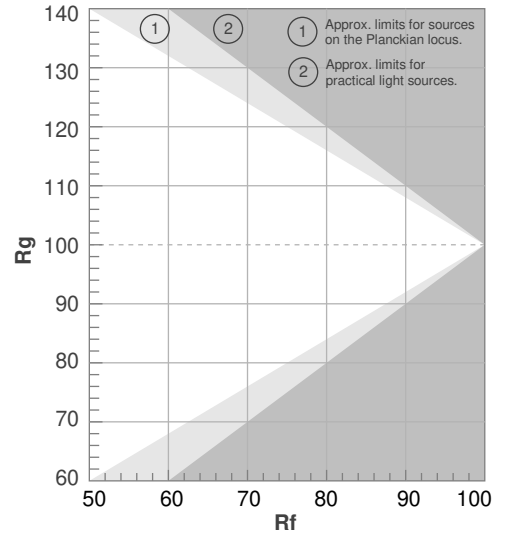

Color Evaluation Sample

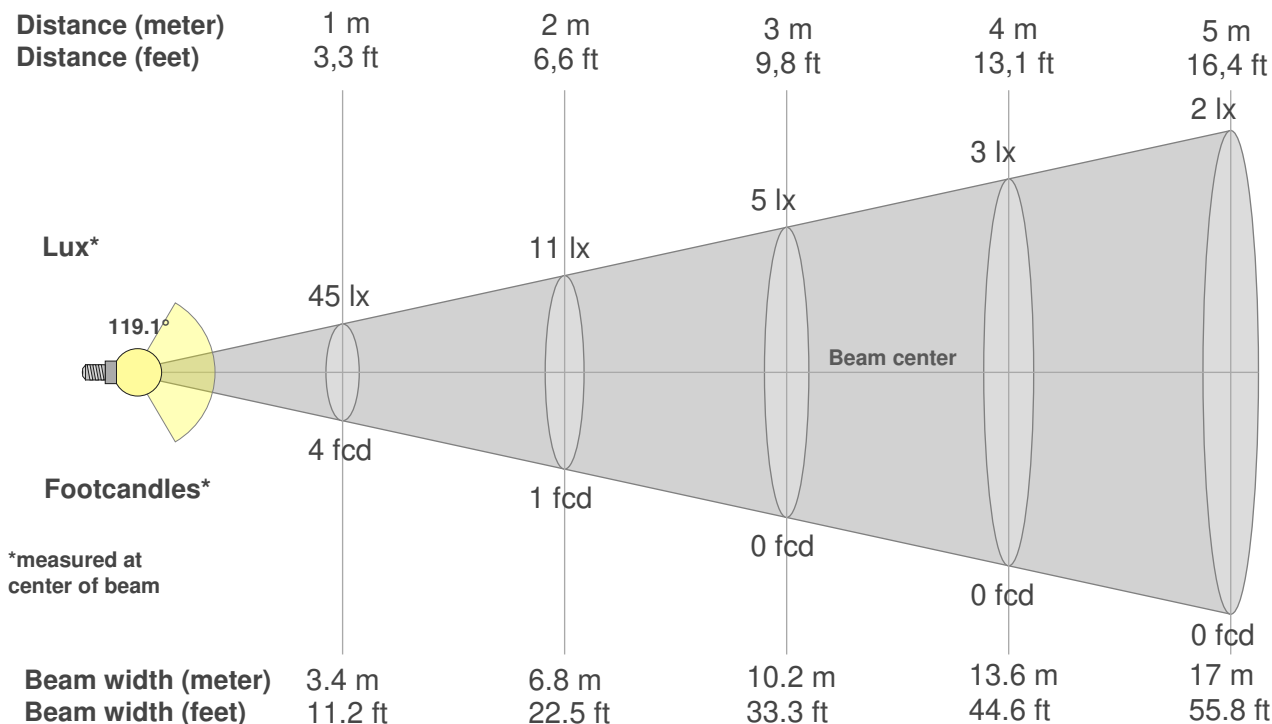

Beam intensities from 1-20m

1m	2m	3m	4m	5m	6m	7m	8m	9m	10m	11m	12m	13m	14m	15m	16m	17m	18m	19m	20m
3.3ft	6.6ft	9.8ft	13.1ft	16.4ft	19.7ft	23ft	26.2ft	29.5ft	32.8ft	36.1ft	39.4ft	42.7ft	45.9ft	49.2ft	52.5ft	55.8ft	59.1ft	62.3ft	65.6ft
45lx	11lx	5lx	3lx	2lx	1lx	1lx	1lx	1lx	0lx	0lx	0lx	0lx	0lx	0lx	0lx	0lx	0lx	0lx	0lx
4.2fcd	1fcd	0.5fcd	0.3fcd	0.2fcd	0.1fcd	0.1fcd	0.1fcd	0.1fcd	0fcd	0fcd	0fcd	0fcd	0fcd	0fcd	0fcd	0fcd	0fcd	0fcd	0fcd

Intensities in 0° c-plane

0°	5°	10°	15°	20°	25°	30°	35°	40°	45°	50°	55°	60°	65°	70°	75°	80°	85°	90°	95°
44.9	44.9	44.4	43.2	42.0	40.5	38.7	36.5	34.0	31.5	28.2	25.3	22.1	18.8	15.4	11.8	8.1	4.7	2.0	0.5
100%	100%	99%	96%	94%	90%	86%	81%	76%	70%	63%	56%	49%	42%	34%	26%	18%	11%	4%	1%

Intensities in 90° c-plane

0°	5°	10°	15°	20°	25°	30°	35°	40°	45°	50°	55°	60°	65°	70°	75°	80°	85°	90°	95°
44.9	44.7	44.2	43.2	42.1	40.6	38.6	36.2	34.0	31.3	28.3	25.4	22.2	18.9	15.8	12.5	9.0	6.0	3.3	1.7
100%	100%	98%	96%	94%	90%	86%	81%	76%	70%	63%	57%	50%	42%	35%	28%	20%	13%	7%	4%

Intensities in 180° c-plane

0°	5°	10°	15°	20°	25°	30°	35°	40°	45°	50°	55°	60°	65°	70°	75°	80°	85°	90°	95°
44.9	44.6	44.2	43.3	42.0	40.4	38.6	36.4	34.0	31.1	28.3	25.4	22.1	18.9	15.2	11.6	7.8	4.5	1.9	0.7
100%	99%	99%	96%	94%	90%	86%	81%	76%	69%	63%	57%	49%	42%	34%	26%	17%	10%	4%	1%

Intensities in 270° c-plane

0°	5°	10°	15°	20°	25°	30°	35°	40°	45°	50°	55°	60°	65°	70°	75°	80°	85°	90°	95°
44.9	44.9	44.5	43.5	42.2	40.8	38.9	36.7	34.0	31.5	28.6	25.3	22.2	18.9	15.6	12.0	8.4	5.4	2.9	1.5
100%	100%	99%	97%	94%	91%	87%	82%	76%	70%	64%	56%	50%	42%	35%	27%	19%	12%	6%	3%

Beam angle 50%	Field angle 10%	Cutoff angle 2,5%	Intensity ratio in 120° cone	Intensity ratio in 90° cone
119.1°	172.4°	192.8°	71.5%	47.8%

Photometric Details



WURM-RGB-WSC-DRY-B-SO-ENC-CL-S1-BW-NA

Product name:	WURM-RGB-WSC-DRY-B-SO-ENC-CL-S1-BW-NA
Date:	9/27/2019
Powering product:	IQ-PH-80-120/24
Output:	26.6 lm/ft
Peak:	7.31 cd
Power:	1.2 W/ft
PF:	1.0



Beam Angle

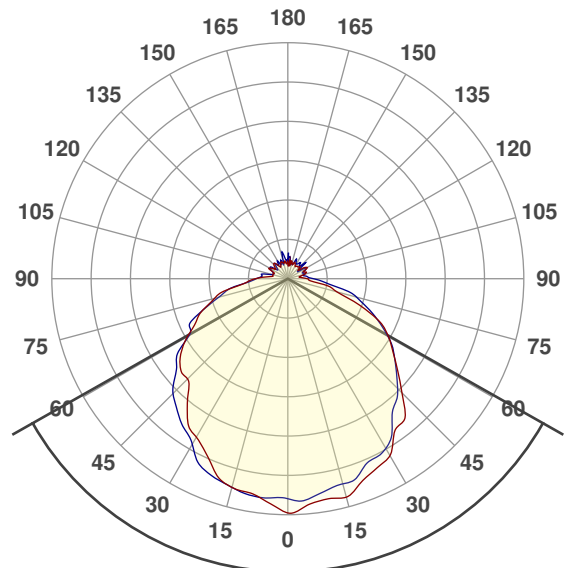

121°

CIE 1931
x: 0.140
y: 0.088

Light efficiency:



Light quality:



Color temperature:



Spectra

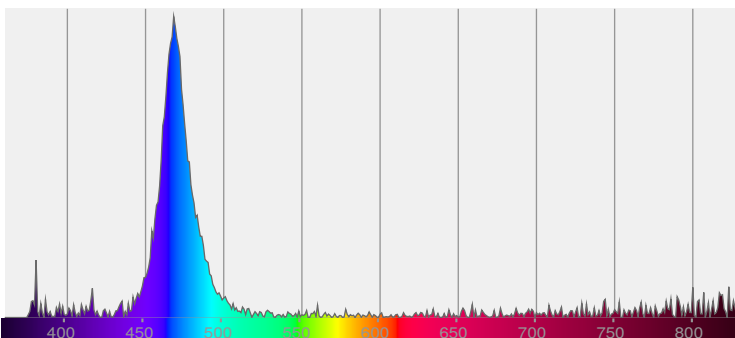

Power

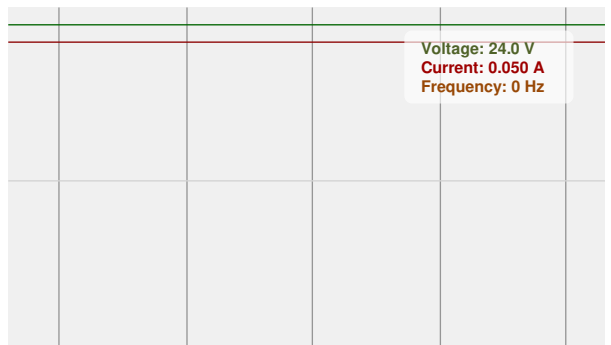

Color Details



WURM-RGB-WSC-DRY-B-SO-ENC-CL-S1-BW-NA

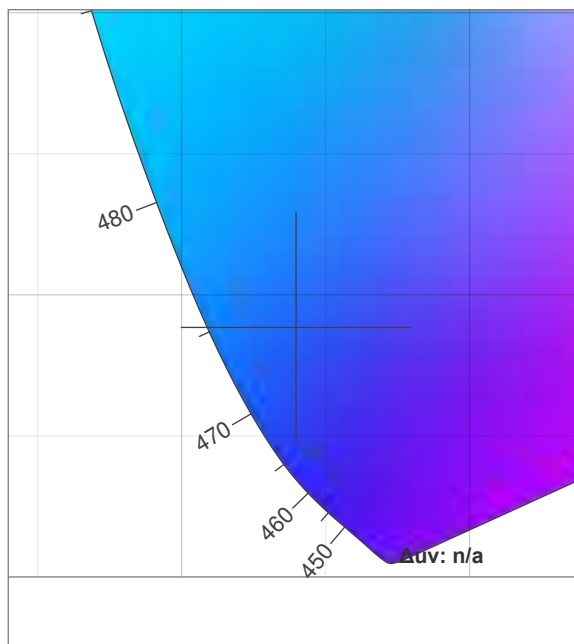
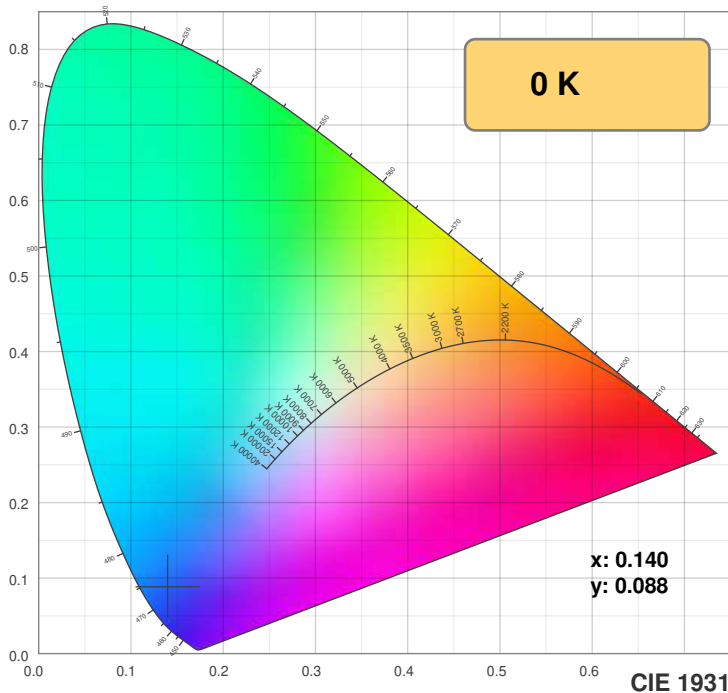

TM30: 0.0

CRI: 0.0 (R1-R8)

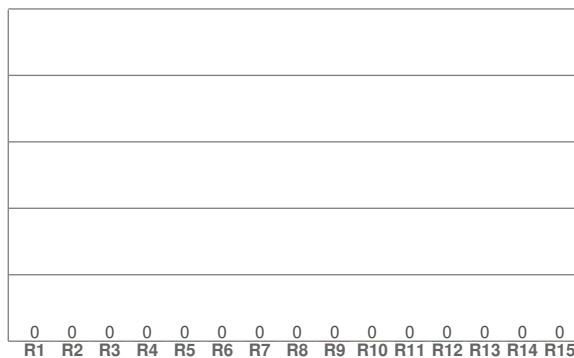
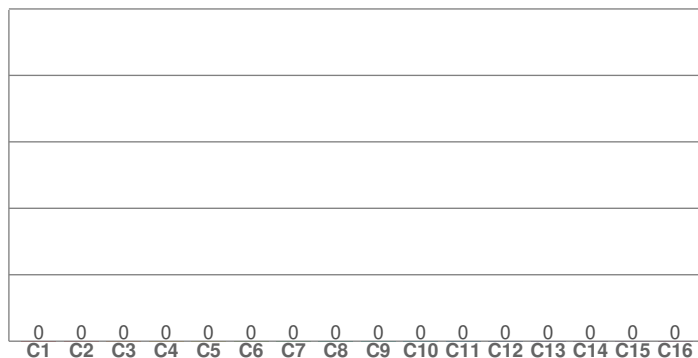

CRI R values, only R1-R8 are used to calculate final CRI value

R1	R2	R3	R4	R5	R6	R7	R8	R9	R10	R11	R12	R13	R14	R15
0.0	0.0	0.0	0.0	0.0	0.0	0.0	0.0	0.0	0.0	0.0	0.0	0.0	0.0	0.0

TM30 C values, 16 binned values out of total of 99 C values

C1	C2	C3	C4	C5	C6	C7	C8	C9	C10	C11	C12	C13	C14	C15	C16
0.0	0.0	0.0	0.0	0.0	0.0	0.0	0.0	0.0	0.0	0.0	0.0	0.0	0.0	0.0	0.0

CQS Q values

Q1	Q2	Q3	Q4	Q5	Q6	Q7	Q8	Q9	Q10	Q11	Q12	Q13	Q14	Q15
0.0	0.0	0.0	0.0	0.0	0.0	0.0	0.0	0.0	0.0	0.0	0.0	0.0	0.0	0.0

CQS: 0.0

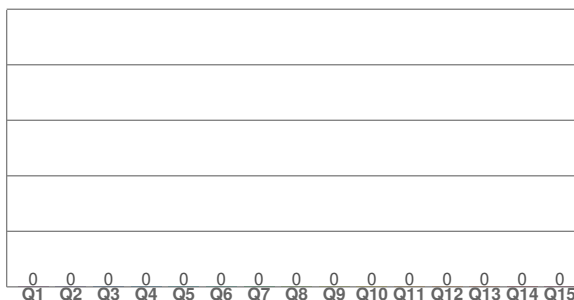

Color parameters

Color temperature	Color rendering index	Red component	Color fidelity	Color gamut	Color quality scale	Color coordinate cie 1931	Color coordinate cie 1931	Color coordinate	Color coordinate	Color deviation from black body
CCT	CRI	CRI R9	TM30 Rf	TM30 Rg	CQS	x	y	u	v	Δuv
0 K	0.0	0.0	0.0	0.0	0.0	0.140	0.088	0.148	0.140	n/a

TM30 Details



WURM-RGB-WSC-DRY-B-SO-ENC-CL-S1-BW-NA

Rf 0.0
Fidelity index Rf

Rg 0.0
Gammut index Rg

Hue Bin	R _f	Graphic shifts (%)	
		Chroma	Hue
1	0	0%	0%
2	0	0%	0%
3	0	0%	0%
4	0	0%	0%
5	0	0%	0%
6	0	0%	0%
7	0	0%	0%
8	0	0%	0%
9	0	0%	0%
10	0	0%	0%
11	0	0%	0%
12	0	0%	0%
13	0	0%	0%
14	0	0%	0%
15	0	0%	0%
16	0	0%	0%

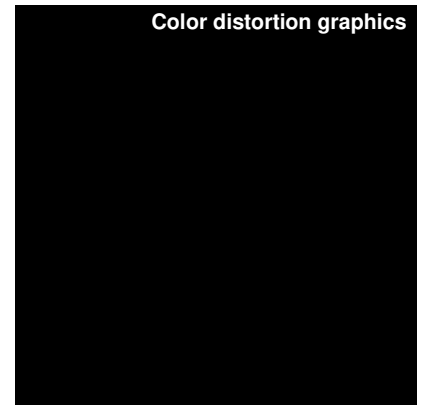
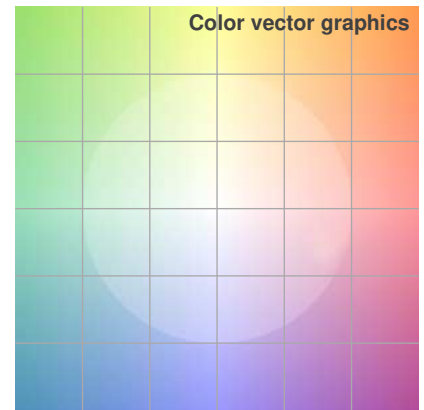
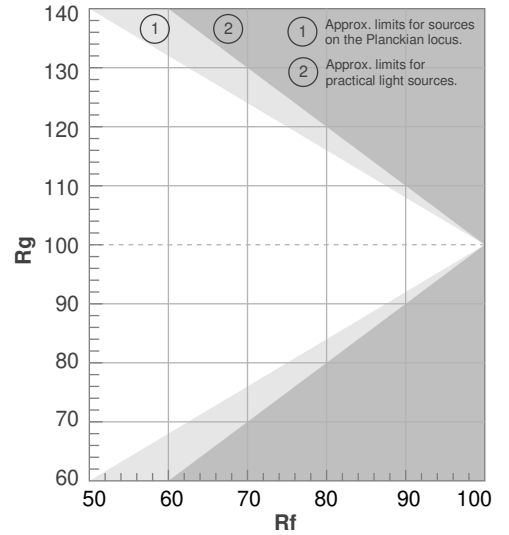

Color Evaluation Sample

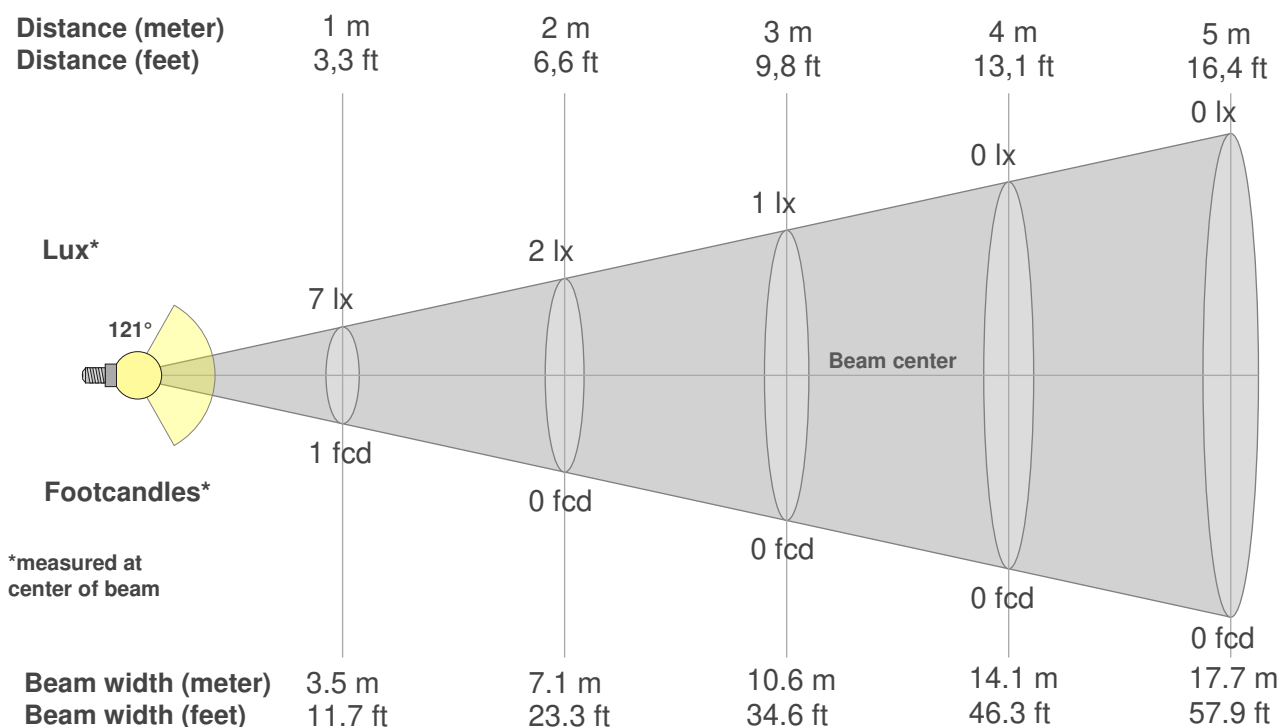

Beam intensities from 1-20m

1m	2m	3m	4m	5m	6m	7m	8m	9m	10m	11m	12m	13m	14m	15m	16m	17m	18m	19m	20m
3.3ft	6.6ft	9.8ft	13.1ft	16.4ft	19.7ft	23ft	26.2ft	29.5ft	32.8ft	36.1ft	39.4ft	42.7ft	45.9ft	49.2ft	52.5ft	55.8ft	59.1ft	62.3ft	65.6ft
7lx	2lx	1lx	0lx	0lx	0lx	0lx	0lx	0lx	0lx	0lx	0lx	0lx	0lx	0lx	0lx	0lx	0lx	0lx	0lx
0.7fcd	0.2fcd	0.1fcd	0fcd	0fcd	0fcd	0fcd	0fcd	0fcd	0fcd	0fcd	0fcd	0fcd	0fcd	0fcd	0fcd	0fcd	0fcd	0fcd	0fcd

Intensities in 0° c-plane

0°	9°	18°	27°	36°	45°	54°	63°	72°	81°	90°	99°	108°	117°	126°	135°	144°	153°	162°	171°
7.07	7.00	6.87	6.46	5.77	5.03	4.10	3.35	2.04	1.13	0.61	0.37	0.59	0.62	0.54	0.52	0.49	0.51	0.47	0.53
100%	99%	97%	91%	82%	71%	58%	47%	29%	16%	9%	5%	8%	9%	8%	7%	7%	7%	7%	8%

Intensities in 90° c-plane

0°	9°	18°	27°	36°	45°	54°	63°	72°	81°	90°	99°	108°	117°	126°	135°	144°	153°	162°	171°
7.07	6.75	6.61	6.20	5.55	4.84	4.10	3.31	2.45	1.51	0.82	0.56	0.55	0.63	0.42	0.61	0.60	0.58	0.48	0.46
100%	96%	93%	88%	78%	68%	58%	47%	35%	21%	12%	8%	8%	9%	6%	9%	8%	8%	7%	7%

Intensities in 180° c-plane

0°	9°	18°	27°	36°	45°	54°	63°	72°	81°	90°	99°	108°	117°	126°	135°	144°	153°	162°	171°
7.07	6.81	6.61	5.89	5.31	4.45	4.14	3.31	2.61	1.74	1.01	0.49	0.49	0.63	0.52	0.61	0.53	0.48	0.54	0.54
100%	96%	94%	83%	75%	63%	59%	47%	37%	25%	14%	7%	7%	9%	7%	9%	7%	7%	8%	8%

Intensities in 270° c-plane

0°	9°	18°	27°	36°	45°	54°	63°	72°	81°	90°	99°	108°	117°	126°	135°	144°	153°	162°	171°
7.07	6.85	6.66	6.28	5.61	5.05	4.27	3.42	2.56	1.75	0.99	0.82	0.48	0.57	0.59	0.48	0.52	0.54	0.52	0.71
100%	97%	94%	89%	79%	71%	60%	48%	36%	25%	14%	12%	7%	8%	8%	7%	7%	8%	7%	10%

Beam angle 50%	Field angle 10%	Cutoff angle 2,5%	Intensity ratio in 120° cone	Intensity ratio in 90° cone
121°	264.4°	360°	61.7%	40.9%