



iQ LED TAPE LIGHT **5050 CHIP SERIES**
iQ20 MULTI-COLOR: DRY RATED



Q-Tran's iQ Multi-Color + White LED combines a 3 color RGB chip with a high CRI white chip to provide a full spectrum of colors and/or a crisp white. The white chip is available in 2700K or 3000K. This product is powered by or eLED power supply with built in DMX decoder.

iQ20 - MW - [] - 90 - [] - []

iQ Series Color Color Temp CRI Watts Per FT Length

FEATURES

- LED life time - 40,000 hours
- Operating Temperature: -4°F ~ +113°F
- RGB in one chip
- High CRI white chip
- Suitable for Dry locations
- Non-Ferrous Material
- 3.94" & 6.56" cut points
- DMX controlled
- 3 year Warranty

iQ20-MW-27-90-3.5

Max Run / Reel Length: 27ft* | Color Temp: 2700K | LM: 79
 Voltage: 24VDC | Watts Per Ft: 3.5 | Lumens Per Ft: 52

iQ20-MW-30-90-3.5

Max Run / Reel Length: 27ft* | Color Temp: 3000K | LM: 79
 Voltage: 24VDC | Watts Per Ft: 3.5 | Lumens Per Ft: 60

iQ20-MW-27-90-6.0

Max Run / Reel Length: 16ft* | Color Temp: 2700K | LM: 79
 Voltage: 24VDC | Watts Per Ft: 6.0 | Lumens Per Ft: 78

iQ20-MW-30-90-6.0

Max Run / Reel Length: 16ft* | Color Temp: 3000K | LM: 79
 Voltage: 24VDC | Watts Per Ft: 6.0 | Lumens Per Ft: White = 89
 Lumens Per Ft: Red = 31 Lumens Per Ft: Blue = 18
 Lumens Per Ft: Green = 71 Lumens Per Ft: All = 200

*Maximum length for one run of iQ20 LED Multi-color White. Individual Power supply cut sheets will provide max distance/loads per power supply.



COMPATIBLE EXTRUSIONS

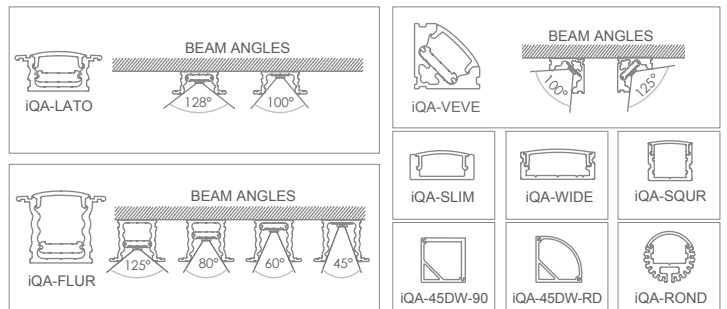

COMPATIBLE POWER SUPPLIES

- Indoor**
- QTM-eLED-DMX
 - QTM-DRIVE

DIMENSIONS

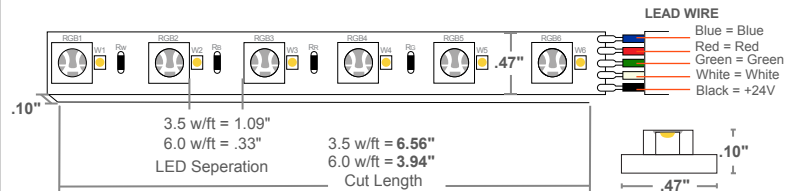

- NOTE**
- Q-Tran offers multiple LED Chip offerings based upon size and pitch, each utilizing its own binning. Utilization of multiple outputs within the same chip family will ensure flawless color matching and similar overall diffusion.
 - Field modifications of factory installed LEDs are not covered under Q-Tran warranty.



Cut marks of LED tape allows for changes in the field.
3.5 watts per foot = cut every 6.56"
6.0 watts per foot = cut every 3.94"
 Lead wire comes standard on all LEDs in 18" (22/5 AWG)

2017.V01

| PROJECT NAME | DATE | COMPANY | TYPE | NOTE |
|--------------|------|---------|------|------|
| | | | | |



iQ LED PHOTOMETRIC

iQ20 6.0 W/ft

iQ20-MW-30-90-6.0

Light efficiency:

62 Lumen/Watt

Light quality:

CRI : 93.6

Color temperature:

2934 K

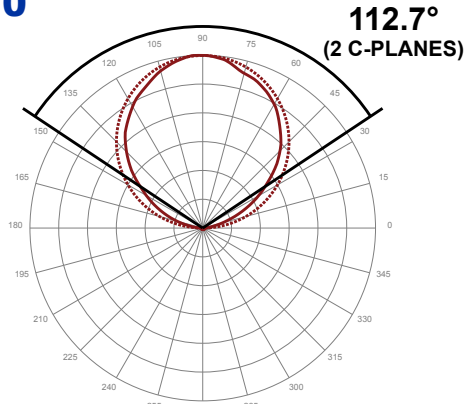

Electrical Test Condition for 1 foot

Output: 89 lm/ft **Peak:** 30.6 cd **Power:** 1.4 W/ft **24V @ 0.06A**

BEAM DETAILS

| Beam angle 50% | Field angle 10% | Cutoff angle 2.5% | Intensity ratio in 120°cone | Intensity ratio in 90°cone |
|----------------|-----------------|-------------------|-----------------------------|----------------------------|
| 112.7° | 162° | 175.1° | 77.0% | 52.4% |

COLOR PARAMETERS

| CCT | CRI | CRI R9 | TM30 Rf | TM30 Rg | CQS | x | y | u | v | Duv |
|--------|------|--------|---------|---------|------|-----|-----|-----|-----|--------|
| 2934 K | 93.6 | 72.1 | 91.4 | 101.1 | 90.4 | 0.4 | 0.4 | 0.3 | 0.3 | 0.0013 |

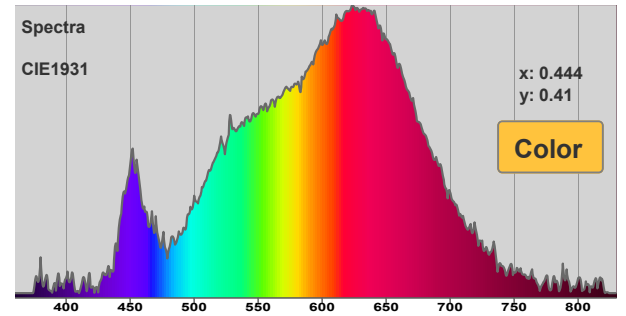
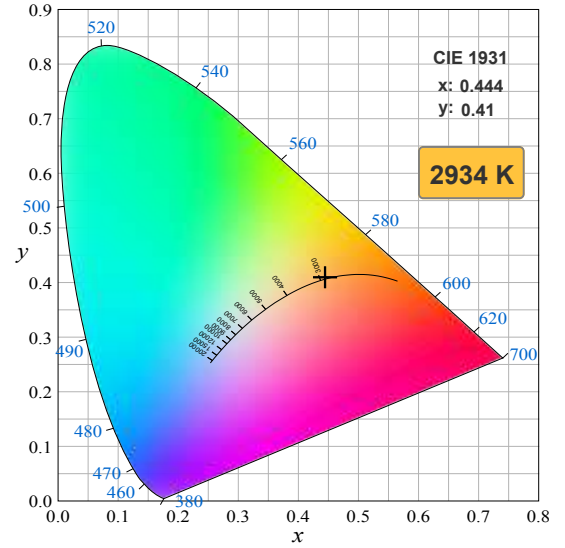

iQ20-MW-30-90-6.0-ALL

Light efficiency:

33 Lumen/Watt

Light quality:

CRI : 53.4

Color temperature:

8681 K

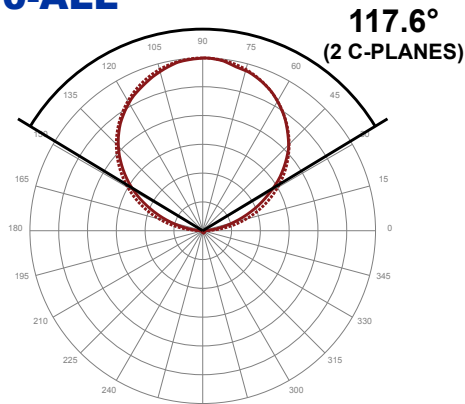

Electrical Test Condition for 1 foot

Output: 200 lm/ft **Peak:** 65.1 cd **Power:** 6 W/ft **24V @ 0.25A**

BEAM DETAILS

| Beam angle 50% | Field angle 10% | Cutoff angle 2.5% | Intensity ratio in 120°cone | Intensity ratio in 90°cone |
|----------------|-----------------|-------------------|-----------------------------|----------------------------|
| 117.6° | 164.7° | 176.1° | 75.9% | 50.9% |

COLOR PARAMETERS

| CCT | CRI | CRI R9 | TM30 Rf | TM30 Rg | CQS | x | y | u | v | Duv |
|--------|------|--------|---------|---------|-----|-----|-----|-----|---|--------|
| 8681 K | 53.4 | -139.5 | 108.2 | 71.9 | 0.3 | 0.3 | 0.3 | 0.3 | 0 | 0.0113 |

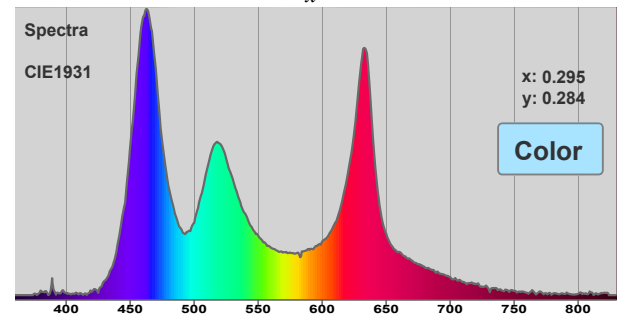
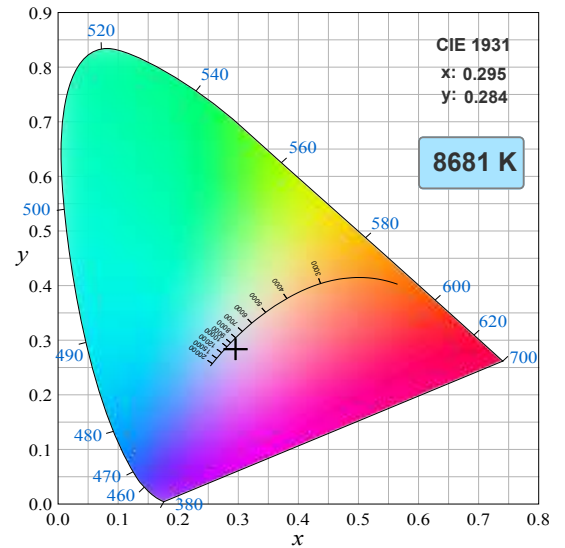



iQ LED PHOTOMETRIC iQ20 6.0 W/ft

iQ20-MW-30-90-6.0-BL

Light efficiency:

13 Lumen/Watt

Light quality:

CRI : 0

Color temperature:

0 K

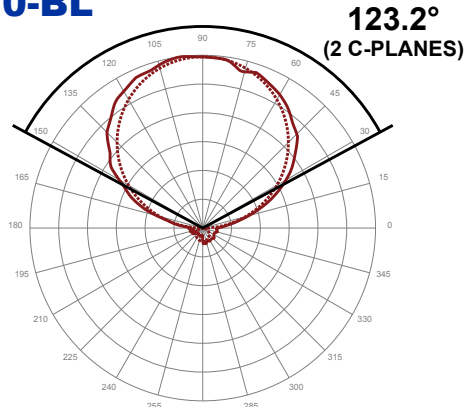

Electrical Test Condition for 1 foot

Output: 18 lm/ft **Peak:** 5.1 cd **Power:** 1.4 W/ft **24V @ 0.06A**

BEAM DETAILS

| Beam angle 50% | Field angle 10% | Cutoff angle 2.5% | Intensity ratio in 120° cone | Intensity ratio in 90° cone |
|----------------|-----------------|-------------------|------------------------------|-----------------------------|
| 123.2° | 171.2° | 360° | 67.4% | 44.4% |

COLOR PARAMETERS

| CCT | CRI | CRI R9 | TM30 Rf | TM30 Rg | CQS | x | y | u | v | Duv |
|-----|-----|--------|---------|---------|-----|-----|-----|-----|-----|--------|
| 0 K | 0 | 0 | 0 | 0 | 0.0 | 0.1 | 0.1 | 0.2 | 0.1 | 0.1858 |

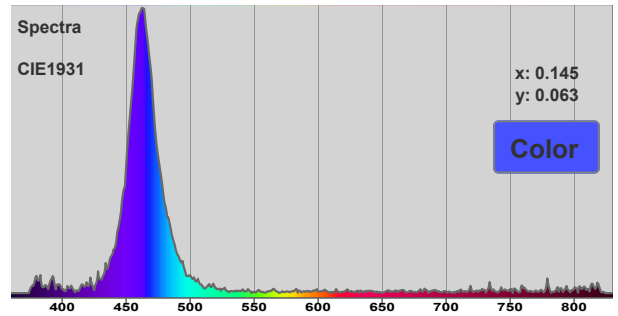
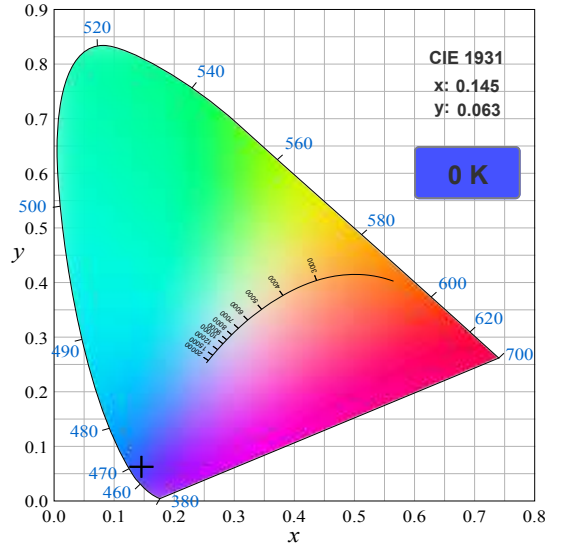

iQ20-MW-30-90-6.0-GR

Light efficiency:

50 Lumen/Watt

Light quality:

CRI : 0

Color temperature:

0 K

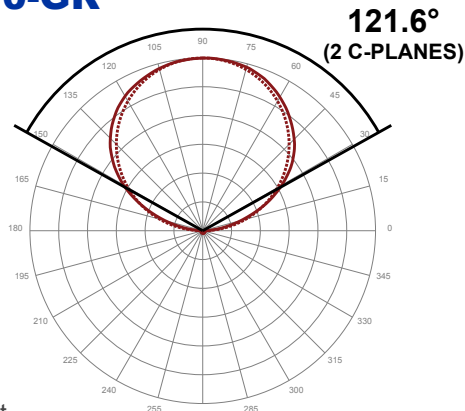

Electrical Test Condition for 1 foot

Output: 71 lm/ft **Peak:** 22 cd **Power:** 1.4 W/ft **24V @ 0.06A**

BEAM DETAILS

| Beam angle 50% | Field angle 10% | Cutoff angle 2.5% | Intensity ratio in 120° cone | Intensity ratio in 90° cone |
|----------------|-----------------|-------------------|------------------------------|-----------------------------|
| 121.6° | 166.5° | 178.3° | 74.4% | 49.3% |

COLOR PARAMETERS

| CCT | CRI | CRI R9 | TM30 Rf | TM30 Rg | CQS | x | y | u | v | Duv |
|-----|-----|--------|---------|---------|-----|-----|-----|-----|-----|--------|
| 0 K | 0 | 0 | 0 | 0 | 0.0 | 0.2 | 0.7 | 0.1 | 0.4 | 0.1591 |

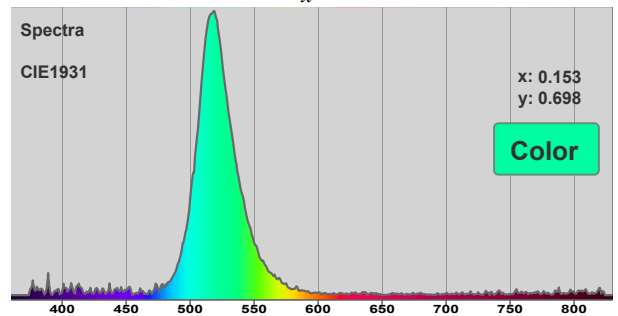
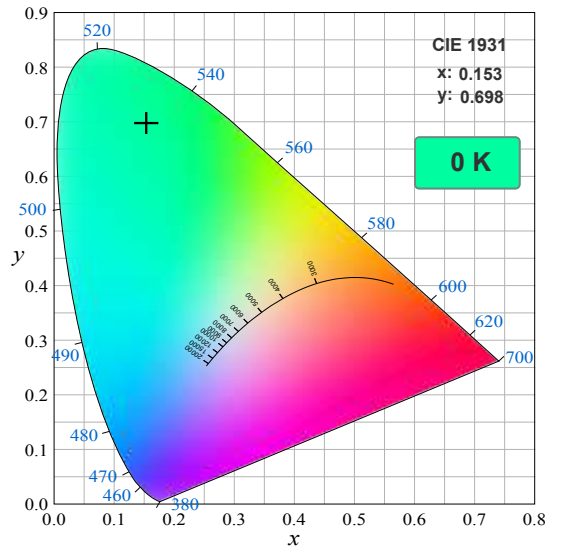



iQ LED PHOTOMETRIC iQ20 6.0 W/ft

iQ20-MW-30-90-6.0-RD

Light efficiency:

22 Lumen/Watt

Light quality:

CRI : 0

Color temperature:

0 K

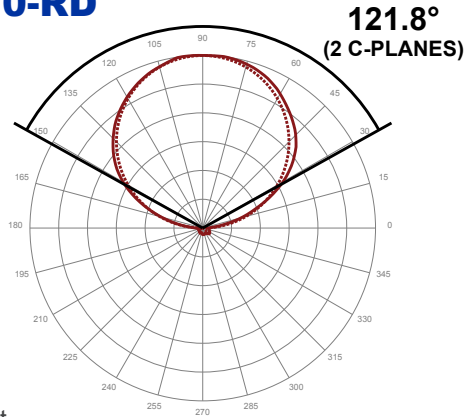

Electrical Test Condition for 1 foot

Output: 31 lm/ft **Peak:** 9.3 cd **Power:** 1.4 W/ft **24V @ 0.06A**

BEAM DETAILS

| Beam angle 50% | Field angle 10% | Cutoff angle 2.5% | Intensity ratio in 120°cone | Intensity ratio in 90°cone |
|-------------------|--------------------|----------------------|--------------------------------|-------------------------------|
| 121.8° | 167.4° | 360° | 71.8% | 47.5% |

COLOR PARAMETERS

| CCT | CRI | CRI R9 | TM30 Rf | TM30 Rg | CQS | x | y | u | v | Duv |
|-----|-----|--------|---------|---------|-----|-----|-----|-----|-----|--------|
| 0 K | 0 | 0 | 0 | 0 | 0.0 | 0.7 | 0.3 | 0.5 | 0.3 | 0.0572 |

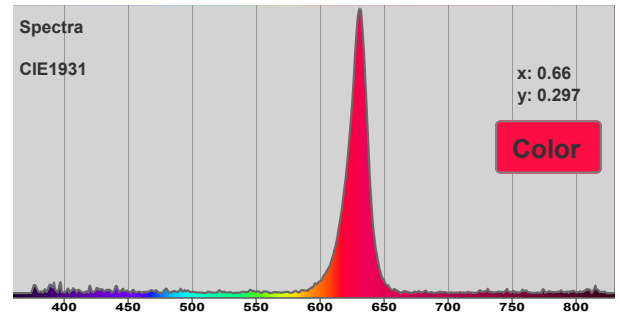
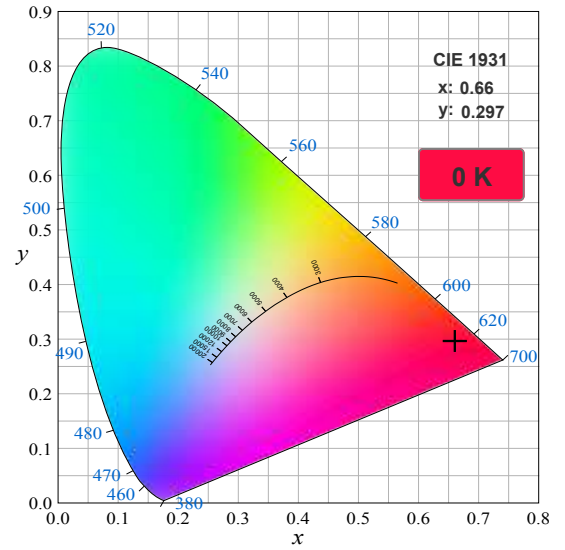



iQ LED TAPE LIGHT

POWER SUPPLY

QTM-eLED+DMX

: for interior

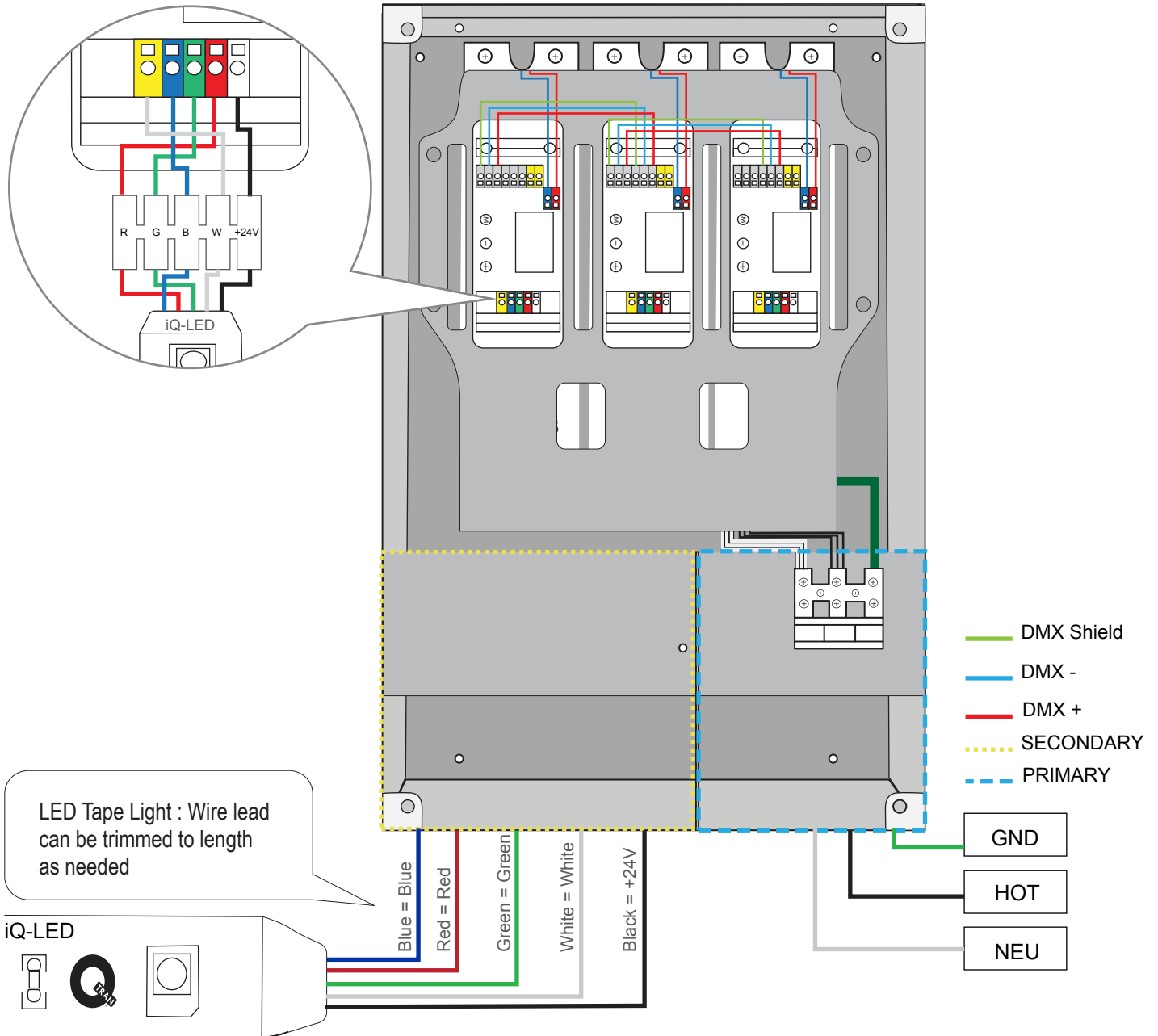



iQ LED TAPE LIGHT

POWER SUPPLY

QTM-DRIVE

: for interior

