

# KURV-SC FIXTURES - FLEXIBLE (Q-CAP)



PRODUCT	MOUNTING	RATED	CCT	OUTPUT	LENS	TYPE	CONNECTOR/ WIRE IN	CONNECTOR/ WIRE OUT	END CAPS (NO FEED)	LENGTH (IN)
<b>KURV-SC</b>	<b>WSC</b> <b>RLC</b> <b>MC</b> <b>*SGC</b> <b>PPS-2</b> <b>PPS-96</b> <b>PPS-FT</b> <b>PPS-LP-2</b> <b>PPS-LP-96</b> <b>PPS-LP-FT</b>	<b>DRY</b> <b>WET</b>	<b>G</b> - Green <b>B</b> - Blue <b>R</b> - Red (FWC) <b>A</b> - Amber (FWC)	<b>VHO</b> <b>VHO</b>	<b>ENC/CL</b> <b>ENC/TL</b>	Single (Closed exit) <b>S1</b> <b>S2</b> <b>S3</b> <b>S4</b> <b><sup>2</sup>S5</b> <b><sup>2</sup>S6</b> Pass through <b>P1</b> <b>P2</b> <b>P3</b> <b>P4</b> <b><sup>2</sup>P5</b>	<b><sup>1</sup>BW</b> <b>BRL</b>	<b>N/A</b>	<b>CL</b> <b>WH</b>  <b>N/A</b>	2" increments from 2"-191"

ENCAPSULATED PRODUCTS ARE NOT FIELD CUTTABLE

- NOTES:**
- Field modifications are not covered under Q-Tran warranty
  - Data subject to change, all data has +/- 5% tolerance
  - FWC Flexible Fixtures are Florida Fish and Wildlife Conservation Commission rated
  - PPS-FT is to be cut at Q-Tran at requested foot length

- <sup>1</sup>BW comes in standard 24" - request custom length (Max 120") by writing it in inches next to "BW" in the order code box (ex. BW48)
- Connector/Wire In or Out not needed to specify product. Standard configuration is Type S1, Connector/Wire In: BW & Connector/Wire Out: N/A with White Endcap (WH)
- <sup>2</sup> PPS mounting clip recommended for seamless applications

## OUTPUT Tested for KURV-SC-WSC-DRY (L70 = 40000 HRS)

CCT	VHO Very High Output			
	ENC/CL		ENC/TL	
	lm/ft	Wavelength	lm/ft	Wavelength
Red	92.3	632	87.4	633
Green	432	520	366	519
Blue	97.7	466	88.4	468
Amber	87.9	595	74.1	594

## LENS with LED visibility

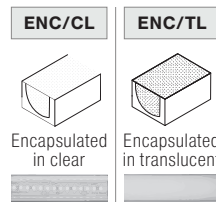

## CONNECTOR/WIRE IN

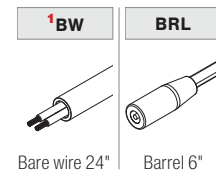

## CONNECTOR/WIRE OUT

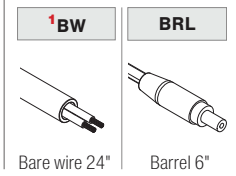

## MOUNTING NOTE: 2 white snug clips provided per first 12", 1 for each additional 12". Other mounting styles incur additional charge, see price guide for details.

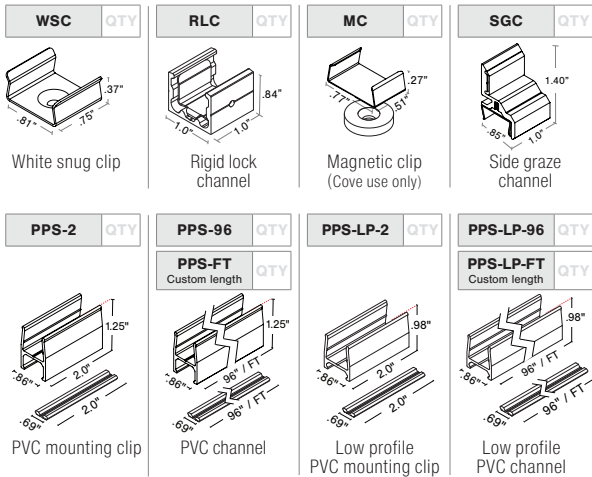

## DIMENSIONS

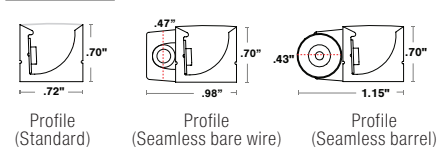

## VIEWING ANGLE

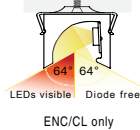

## TYPE

### SINGLE (Input only)

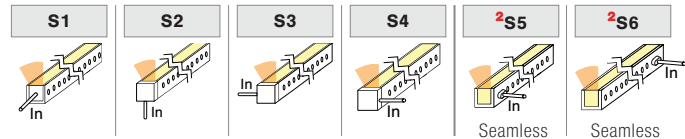

### PASS THROUGH (Input/Output)

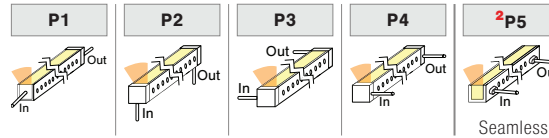

### ORDER EXAMPLE



## FLEXIBILITY

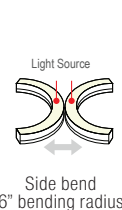

## SEAMLESS

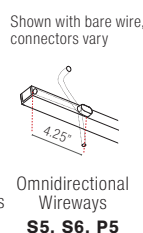

## END CAPS (NO FEED)

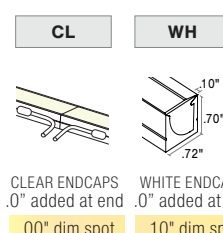

## END CAPS (WITH FEED)

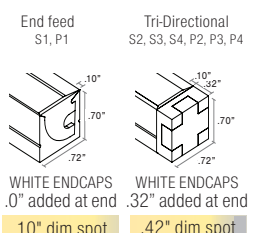

PROJECT NAME	DATE	COMPANY	TYPE	NOTE