

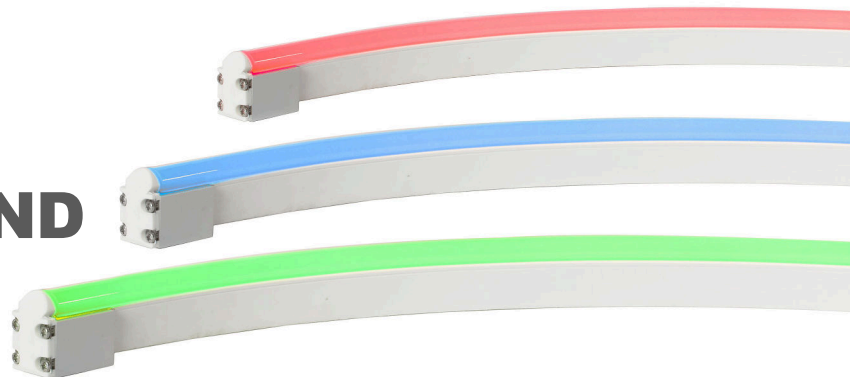

FLEX SERIES IP67

FLEX ROUND

STATIC COLOR:
WET RATED



The FLEX Series is the ideal LED for architectural spaces where the light will be in direct view. As the name implies, these LED lights are flexible and can be easily molded into different curvatures. The enclosure and the lens allow for a perfect monochromatic light source with no hot spots. All of Q-Tran's FLEX Series lights are made with high quality SMD LED chips, are UV and flame resistant, and are extremely energy efficient. The FLEX Round Static colors are available in red, green and blue. Perfect replacement for glass Neon such as indoor, outdoor, signage & architecture.



iQ67-RD-FLR-3.3

Max Run / Reel Length: 30ft | Color : RED (RD)
Voltage: 24VDC | Watts Per Ft: 3.3 | FLR= Flex Round
Lumens per foot: 37 | Wave length: 620-630nm

iQ67-GR-FLR-3.3

Max Run / Reel Length: 30ft | Color : GREEN (GR)
Voltage: 24VDC | Watts Per Ft: 3.3 | FLR= Flex Round
Lumens per foot: 85 | Wave length: 520-530nm

iQ67-BL-FLR-3.3

Max Run / Reel Length: 30ft | Color : BLUE (BL)
Voltage: 24VDC | Watts Per Ft: 3.3 | FLR= Flex Round
Lumens per foot: 12 | Wave length: 465-475nm

STANDARD DIMENSION

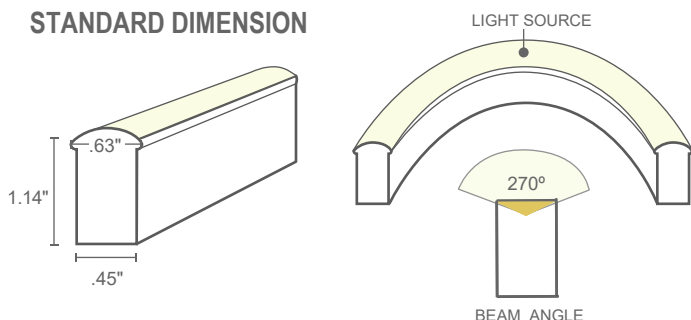

COMPATIBLE EXTRUSIONS

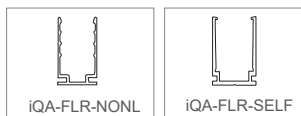

FEATURES

- High quality SMD LED chip
- Ambient temperature: -4°F ~ +113°F
- UV & Flame resistant construction
- Uniform & Even light source with no LED "hotspots"
- 4.72" min. bending diameter
- Run lengths up to 60 feet*
- *For runs greater than 30 feet, 2 independent 100W drivers are required. One powering and wired to each end.
- Environmentally friendly & energy efficient
- UL 2108 – Low Voltage Lighting Systems
- UL 1598 – Luminaires
- 2 year warranty

NOTE: The warranty is only valid if compatible power supplies are used.

COMPATIBLE POWER SUPPLIES

Interior Applications

- Q6M-DC+CAP
- QTM-eLED, QTM-DC+CAP
- iQ-PH

Exterior Applications

- QOM-eLED, QOM-DC+CAP
- Q-SET-eLED
- iQ-PH

CUTTING INSTRUCTIONS:

This flex light can be cut on the dotted line mapped on the unit at every:

Flex Round Red = 6.56"

Flex Round Green & Blue = 3.94"



2019 0606 - V01

PROJECT NAME	DATE	COMPANY	TYPE	NOTE



FLEX SERIES IP67

COMPATIBLE EXTRUSIONS

iQA-FLR-NONL: Non-Self-locking aluminum profile

Length	: 1.5, 19.75, 39.5, 79 in
Dimension	: 0.54 x 0.86 x 0.52 in
Material	: Anodized Aluminum
Fits	: Flex Meza, Flex Round
Screws	: 0.72 x 0.27 in

iQA-FLR-SELF: Self-locking aluminum profile (Used with clip)

Length	: 1.5, 19.75, 39.5, 79 in
Dimension	: 0.65 x 0.93 x 0.67 in
Material	: Anodized Aluminum
Fits	: Flex Meza, Flex Round
Screws	: 0.72 x 0.27 in



FLEX SERIES IP67

TYPES OF CONNECTOR

INJECTION-MOLDED CONNECTOR

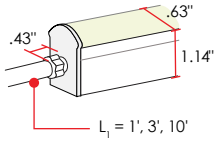

FLR - IMFC -
FRONT L = 1', 3', 10'

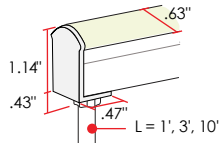

FLR - IMBC -
BACK L = 1', 3', 10'

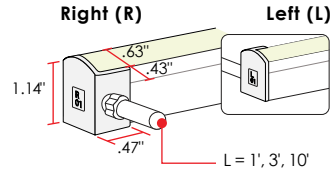

FLR - IMSC - -
SIDE L or R L = 1', 3', 10'

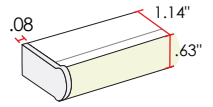

FLR - IMEC
END CAP

SNAP CONNECTOR

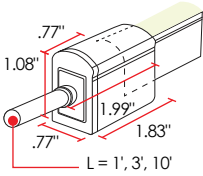

FLR - SNFC -
FRONT L = 1', 3', 10'

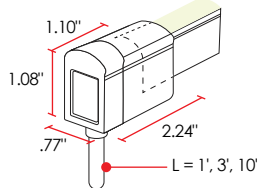

FLR - SNBC -
BACK L = 1', 3', 10'

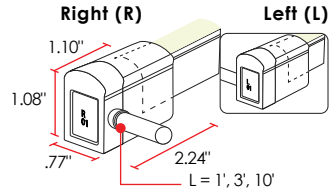

FLR - SNSC - -
SIDE L or R L = 1', 3', 10'

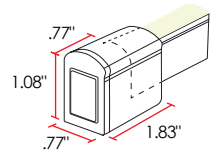

FLR - SNEC
END CAP

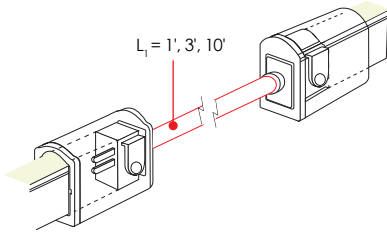

FLR - SNJC -
JUMPER L = 1', 3', 10'



FLEX SERIES IP67

FLEX ROUND

AMBER: WET RATED



The FLEX Series is the ideal LED for architectural spaces where the light will be in direct view. As the name implies, these LED lights are flexible and can be easily molded into different curvatures. The enclosure and the lens allow for a perfect monochromatic light source with no hot spots. All of Q-Tran's FLEX Series lights are made with high quality SMD LED chips, are UV and flame resistant, and are extremely energy efficient. Perfect replacement for glass Neon such as indoor, outdoor, signage & architecture. The amber color is turtle friendly for an eco-friendly option when designing a beach-front property

iQ67	-	AB	-	FLR	-	3.3	-	
iQ series		Color		Flex series		Watts Per FT		Length

iQ67-AB-FLR-3.3

Max Run / Reel Length: 30ft | Color : Amber (AB)
 Voltage: 24VDC | Watts Per Ft: 3.3 | FLR= Flex Round
 Lumens per foot: 40.5

STANDARD DIMENSION

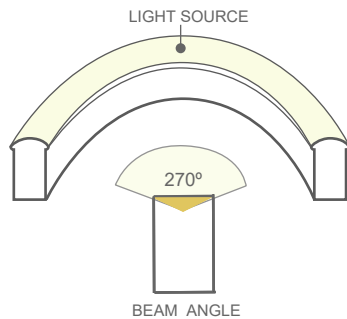
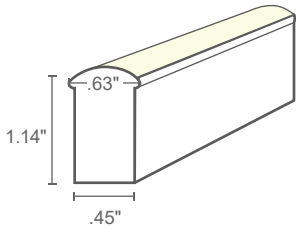

COMPATIBLE EXTRUSIONS

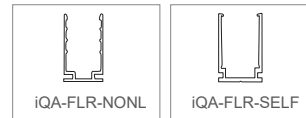

FEATURES

- High quality SMD LED chip
- Ambient temperature: -4°F ~ +113°F
- UV & Flame resistant construction
- Uniform & Even light source w/no LED "hotspots"
- 4.72" min. bending diameter
- Wave length : 585 - 595nm
- Run lengths up to 60 feet*
- *For runs greater than 30 feet, 2 independent 100W drivers are required. One powering and wired to each end.
- Environmentally friendly & energy efficient
- UL 2108 – Low Voltage Lighting Systems
- UL 1598 – Luminaires
- 2 year warranty

NOTE: The warranty only valid if compatible power supplies used.

COMPATIBLE POWER SUPPLIES

Interior Applications

- Q6M-DC+CAP
- QTM-eLED, QTM-DC+CAP
- iQ-PH

Exterior Applications

- QOM-eLED, QOM-DC+CAP
- Q-SET-eLED
- iQ-PH

CUTTING INSTRUCTIONS:

This flex light can be cut on the dotted line mapped on the unit at every 6.56".



2019 0606 - V01

PROJECT NAME	DATE	COMPANY	TYPE	NOTE



FLEX SERIES IP67

COMPATIBLE EXTRUSIONS

iQA-FLR-NONL: Non-Self-locking aluminum profile

Technical drawing of the iQA-FLR-NONL aluminum profile. It includes a side view showing a 7.85" length and a 0.72" diameter screw hole. A detail view shows a 0.27" diameter hole with a 0.72" diameter. The profile dimensions are 0.54" wide, 0.86" high, and 0.52" deep. A bottom view shows a 19.75" length with a 7.85" segment. A Flex LED view shows a 4" segment with a Q-Tran LED strip.

Length	: 1.5, 19.75, 39.5, 79 in
Dimension	: 0.54 x 0.86 x 0.52 in
Material	: Anodized Aluminum
Fits	: Flex Meza, Flex Round
Screws	: 0.72 x 0.27 in

iQA-FLR-SELF: Self-locking aluminum profile (Used with clip)

Technical drawing of the iQA-FLR-SELF aluminum profile. It includes a side view showing a 39.5" length and a 0.78" height. A detail view shows a 0.67" wide, 0.82" high, and 0.93" deep profile. The profile dimensions are 0.65" wide, 0.54" high, and 0.41" deep. An assembly detail shows the profile being secured with clips.

Length	: 1.5, 19.75, 39.5, 79 in
Dimension	: 0.65 x 0.93 x 0.67 in
Material	: Anodized Aluminum
Fits	: Flex Meza, Flex Round
Screws	: 0.72 x 0.27 in



FLEX SERIES IP67

TYPES OF CONNECTOR

INJECTION-MOLDED CONNECTOR

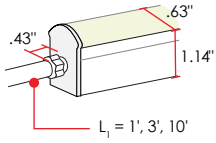

FLR	-	IMFC	-	AB	-	
FRONT		L = 1', 3', 10'				

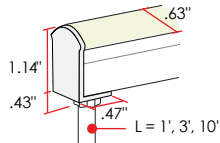

FLR	-	IMBC	-	AB	-	
BACK		L = 1', 3', 10'				

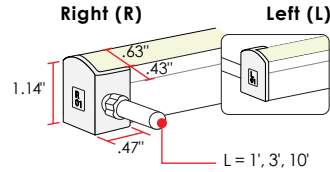

FLR	-	IMSC	-	AB	-	
SIDE		L or R		L = 1', 3', 10'		

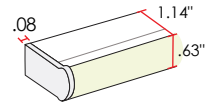

FLR	-	IMEC
END CAP		

SNAP CONNECTOR

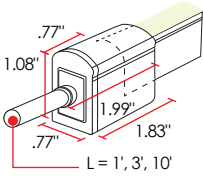

FLR	-	SNFC	-	AB	-	
FRONT		L = 1', 3', 10'				

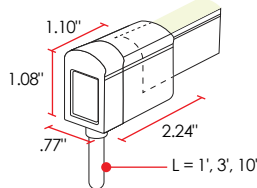

FLR	-	SNBC	-	AB	-	
BACK		L = 1', 3', 10'				

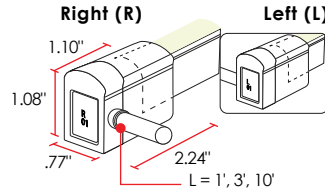

FLR	-	SNSC	-	AB	-	
SIDE		L or R		L = 1', 3', 10'		

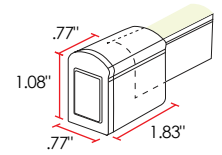

FLR	-	SNEC
END CAP		

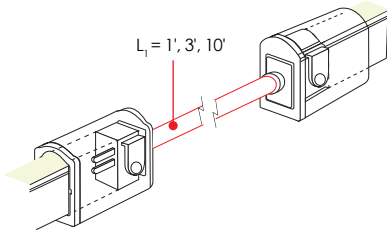

FLR	-	SNJC	-	AB	-	
JUMPER		L = 1', 3', 10'				