

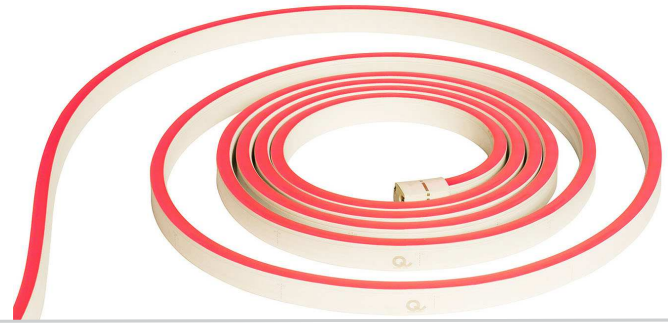

FLEX SERIES IP67
FLEX MINI
 STATIC COLOR:
 WET RATED



The FLEX Series is the ideal LED for architectural spaces where the light will be in direct view. As the name implies, these LED lights are flexible and can be easily molded into different curvatures. The enclosure and the lens allow for a perfect monochromatic light source with no hot spots. All of Q-Tran's FLEX Series lights are made with high quality SMD LED chips, are UV and flame resistant, and are extremely energy efficient. The FLEX Mini Static colors are available in red, green, blue and amber. The amber color is turtle friendly for an eco-friendly option when designing a beach-front property.

| | | | | | | |
|-------------|---|------------|-------------|--------------|--------|--|
| iQ67 | - | FLM | - | 1.4 | - | |
| iQ series | | Color | Flex series | Watts Per FT | Length | |

iQ67-RD-FLM-1.4

Max Run / Reel Length: 30ft | Color : RED(RD)
 Voltage: 24VDC | Watts Per Ft: 1.4 | FLM= Flex Mini
 Lumens per foot: 14 | Wave length: 620-630nm



iQ67-GR-FLM-1.4

Max Run / Reel Length: 30ft | Color : GREEN (GR)
 Voltage: 24VDC | Watts Per Ft: 1.4 | FLM= Flex Mini
 Lumens per foot: 24 | Wave length: 520-530nm

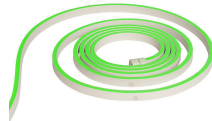

iQ67-BL-FLM-1.4

Max Run / Reel Length: 30ft | Color : BLUE (BL)
 Voltage: 24VDC | Watts Per Ft: 1.4 | FLM= Flex Mini
 Lumens per foot: 5 | Wave length: 465-475nm

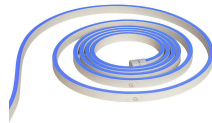

COMPATIBLE EXTRUSIONS

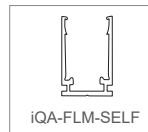

FEATURES

- IK08 rated
- High quality SMD LED chip
- Ambient temperature: -4°F ~ +113°F
- UV & Flame resistant construction
- Uniform & Even light source w/no LED "hotspots"
- 3.54" min. bending diameter
- Run lengths up to 60 feet*
- *For runs greater than 30 feet, 2 independent 100W drivers are required. One powering and wired to each end.
- Environmentally friendly & energy efficient
- UL 2108 – Low Voltage Lighting Systems
- UL 1598 – Luminaires
- 2 year warranty

NOTE: The warranty only valid if compatible power supplies used.

COMPATIBLE POWER SUPPLIES

Interior Applications

- Q6M-DC+CAP
- QTM-eLED, QTM-DC+CAP
- iQ-PH

Exterior Applications

- QOM-eLED, QOM-DC+CAP
- Q-SET-eLED
- iQ-PH

STANDARD DIMENSION

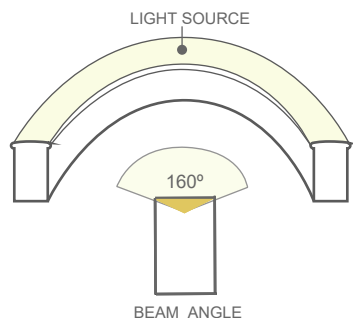
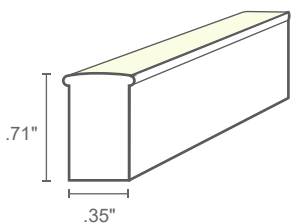

CUTTING INSTRUCTIONS:

This flex light can be cut on the dotted line mapped on the unit at every:

- Flex Mini Red = 4.92"
- Flex Mini Green & Blue = 3.28"



2019 0606 - V01

| PROJECT NAME | DATE | COMPANY | TYPE | NOTE |
|--------------|------|---------|------|------|
| | | | | |



FLEX SERIES IP67

COMPATIBLE EXTRUSIONS

iQA-FLM-SELF: Self-locking aluminum profile (Used with clip)

The technical drawing includes a cross-section of the aluminum profile with the following dimensions: a top width of 0.50", a bottom width of 0.50", a total height of 0.88", a top flange height of 0.76", and a bottom flange height of 0.24". A perspective view shows a 39.5" long profile with a clip being inserted into the bottom channel. A circular inset provides a close-up of the clip's locking mechanism.

| | |
|------------------|---------------------------|
| Length | : 1.5, 19.75, 39.5, 79 in |
| Dimension | : 0.50 x 0.88 x 0.50 in |
| Material | : Anodized Aluminum |
| Fits | : Flex Mini |
| Screws | : 0.72 x 0.27 in |



FLEX SERIES IP67

TYPES OF CONNECTOR

INJECTION-MOLDED CONNECTOR

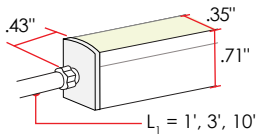

FLM - IMFC -
FRONT L = 1', 3', 10'

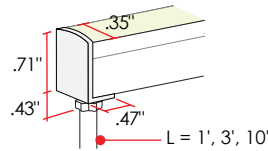

FLM - IMBC -
BACK L = 1', 3', 10'

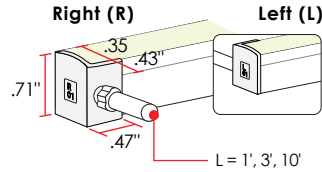

FLM - IMSC - -
SIDE L or R L = 1', 3', 10'

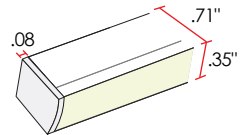

FLM - IMEC
END CAP

SNAP CONNECTOR

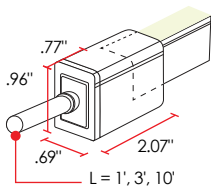

FLM - SNFC -
FRONT L = 1', 3', 10'

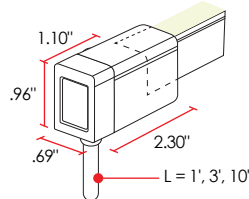

FLM - SNBC -
BACK L = 1', 3', 10'

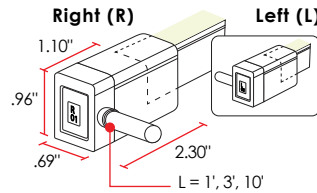

FLM - SNSC - -
SIDE L or R L = 1', 3', 10'

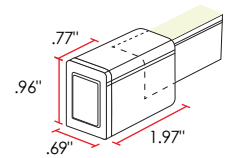

FLM - SNEC
END CAP

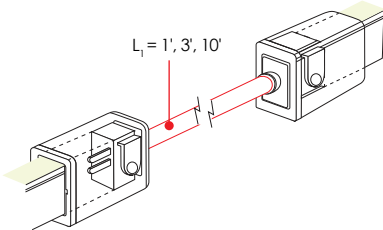

FLM - SNJC -
JUMPER L = 1', 3', 10'



FLEX SERIES IP67
FLEX MINI
 AMBER: WET RATED



The FLEX Series is the ideal LED for architectural spaces where the light will be in direct view. As the name implies, these LED lights are flexible and can be easily molded into different curvatures. The enclosure and the lens allow for a perfect monochromatic light source with no hot spots. All of Q-Tran's FLEX Series lights are made with high quality SMD LED chips, are UV and flame resistant, and are extremely energy efficient. Perfect replacement for glass Neon such as indoor, outdoor, signage & architecture. The amber color is turtle friendly for an eco-friendly option when designing a beach-front property

| | | | | | | | | |
|-------------|---|-----------|---|-------------|---|--------------|---|--------|
| iQ67 | - | AB | - | FLM | - | 1.4 | - | |
| iQ series | | Color | | Flex series | | Watts Per FT | | Length |

iQ67-AB-FLM-1.4

Max Run / Reel Length: 30ft | Color : Amber (AB)
 Voltage: 24VDC | Watts Per Ft: 1.4 | FLM= Flex Mini
 Lumens per foot: 25.3

STANDARD DIMENSION

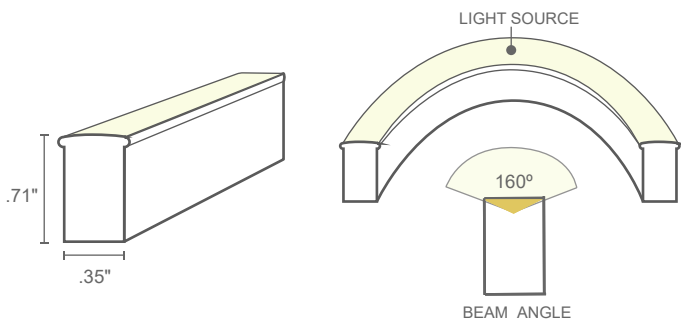

COMPATIBLE EXTRUSIONS

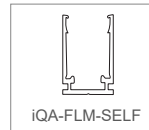

FEATURES

- IK08 rated
- High quality SMD LED chip
- Ambient temperature: -4°F ~ +113°F
- UV & Flame resistant construction
- Uniform & Even light source w/no LED "hotspots"
- 3.54" min. bending diameter
- Wave length : 585 - 595nm
- Run lengths up to 60 feet*
- *For runs greater than 30 feet, 2 independent 100W drivers are required. One powering and wired to each end.
- Environmentally friendly & energy efficient
- UL 2108 – Low Voltage Lighting Systems
- UL 1598 – Luminaires
- 2 year warranty

NOTE: The warranty only valid if compatible power supplies used.

COMPATIBLE POWER SUPPLIES

Interior Applications

- Q6M-DC+CAP
- QTM-eLED, QTM-DC+CAP
- iQ-PH

Exterior Applications

- QOM-eLED, QOM-DC+CAP
- Q-SET-eLED
- iQ-PH

CUTTING INSTRUCTIONS:

This flex light can be cut on the dotted line mapped on the unit at every 4.92".



2019 0606 - V01

| PROJECT NAME | DATE | COMPANY | TYPE | NOTE |
|--------------|------|---------|------|------|
| | | | | |



FLEX SERIES IP67

COMPATIBLE EXTRUSIONS

iQA-FLM-SELF: Self-locking aluminum profile (Used with clip)

The technical drawing includes a cross-section of the aluminum profile with the following dimensions: a top width of 0.50", a bottom width of 0.50", a total height of 0.88", a top flange height of 0.76", and a bottom flange height of 0.24". A perspective view shows a 39.5" long profile with two clips attached. A circular inset provides a detailed view of the clip mechanism.

| | |
|------------------|---------------------------|
| Length | : 1.5, 19.75, 39.5, 79 in |
| Dimension | : 0.50 x 0.88 x 0.50 in |
| Material | : Anodized Aluminum |
| Fits | : Flex Mini |
| Screws | : 0.72 x 0.27 in |



FLEX SERIES IP67

TYPES OF CONNECTOR

INJECTION-MOLDED CONNECTOR

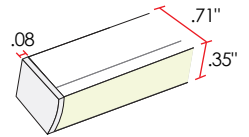
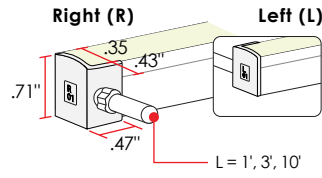
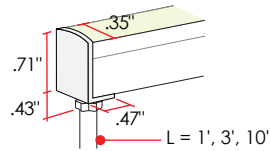
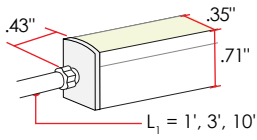

SNAP CONNECTOR

