

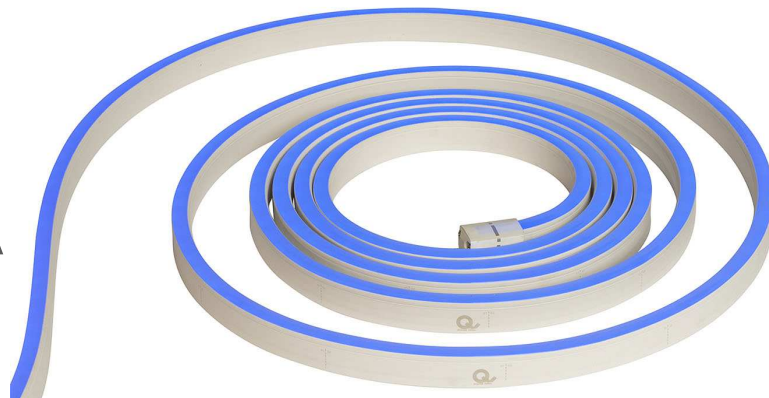

FLEX SERIES IP67
FLEX MEZA
 STATIC COLOR:
 WET RATED



The FLEX Series is the ideal LED for architectural spaces where the light will be in direct view. As the name implies, these LED lights are flexible and can be easily molded into different curvatures. The enclosure and the lens allow for a perfect monochromatic light source with no hot spots. All of Q-Tran's FLEX Series lights are made with high quality SMD LED chips, are UV and flame resistant, and are extremely energy efficient. The FLEX Meza Static colors are available in red, green and blue. Perfect replacement for glass Neon such as indoor, outdoor, signage & architecture.

| | | | | | | | | |
|-------------|---|----------------------|---|-------------|---|--------------|---|----------------------|
| iQ67 | - | <input type="text"/> | - | FMZ | - | 3.3 | - | <input type="text"/> |
| iQ series | | Color | | Flex series | | Watts Per FT | | Length |

COMPATIBLE EXTRUSIONS

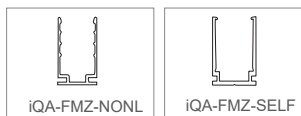

FEATURES

- IK08 rated
- High quality SMD LED chip
- Ambient temperature: -4°F ~ +113°F
- UV & Flame resistant construction
- Uniform & Even light source w/no LED "hotspots"
- 4.72" min. bending diameter
- Run lengths up to 60 feet*

*For runs greater than 30 feet, 2 independent 100W drivers are required. One powering and wired to each end.

- Environmentally friendly & energy efficient
- UL 2108 – Low Voltage Lighting Systems
- UL 1598 – Luminaires
- 2 year warranty

NOTE: The warranty is only valid if compatible power supplies are used.

COMPATIBLE POWER SUPPLIES

Interior Applications

- Q6M-DC+CAP
- QTM-eLED, QTM-DC+CAP
- iQ-PH

Exterior Applications

- QOM-eLED, QOM-DC+CAP
- Q-SET-eLED
- iQ-PH

iQ67-RD-FMZ-3.3

Max Run / Reel Length: 30ft | Color : RED(RD)
 Voltage: 24VDC | Watts Per Ft: 3.3 | FMZ= Flex Meza
 Lumens per foot: 34 | Wave length: 620-630nm



iQ67-GR-FMZ-3.3

Max Run / Reel Length: 30ft | Color : GREEN (GR)
 Voltage: 24VDC | Watts Per Ft: 3.3 | FMZ= Flex Meza
 Lumens per foot: 92 | Wave length: 520-530nm



iQ67-BL-FMZ-3.3

Max Run / Reel Length: 30ft | Color : BLUE (BL)
 Voltage: 24VDC | Watts Per Ft: 3.3 | FMZ= Flex Meza
 Lumens per foot: 24 | Wave length: 465-475nm



STANDARD DIMENSION

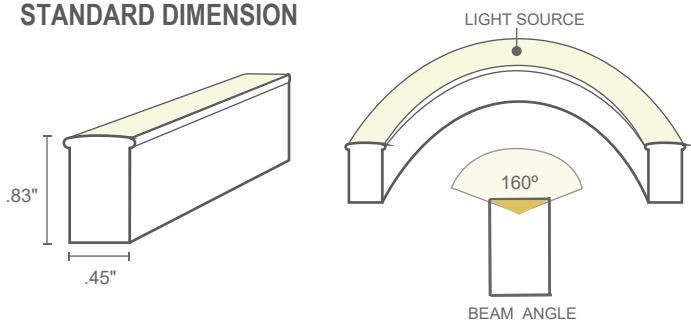

CUTTING INSTRUCTIONS:

This flex light can be cut on the dotted line mapped on the unit at every:

- Flex Meza Red = 6.56"
- Flex Meza Green & Blue = 3.94"



20190606 - V01

| PROJECT NAME | DATE | COMPANY | TYPE | NOTE |
|--------------|------|---------|------|------|
| | | | | |



FLEX SERIES IP67 COLOR DATA

GREEN



CRI: 0.0
CRI R9: 0.0
TM30 Rf: 0.0
TM30 Rg: 0.0
CQS: 0.0
X: 0.160
Y: 0.682
U: 0.059
V: 0.377
Δuv: n/a

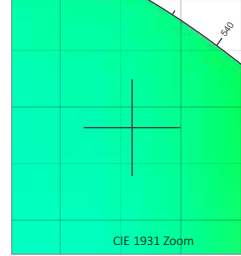
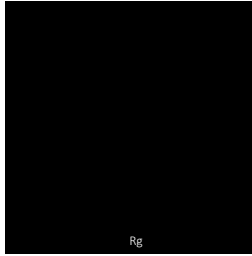
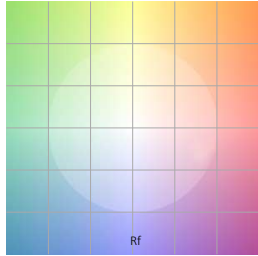

| R1 | R2 | R3 | R4 | R5 | R6 | R7 | R8 | R9 | R10 | R11 | R12 | R13 | R14 | R15 | |
|-----|-----|-----|-----|-----|-----|-----|-----|-----|-----|-----|-----|-----|-----|-----|-----|
| 0.0 | 0.0 | 0.0 | 0.0 | 0.0 | 0.0 | 0.0 | 0.0 | 0.0 | 0.0 | 0.0 | 0.0 | 0.0 | 0.0 | 0.0 | |
| Q1 | Q2 | Q3 | Q4 | Q5 | Q6 | Q7 | Q8 | Q9 | Q10 | Q11 | Q12 | Q13 | Q14 | Q15 | |
| 0.0 | 0.0 | 0.0 | 0.0 | 0.0 | 0.0 | 0.0 | 0.0 | 0.0 | 0.0 | 0.0 | 0.0 | 0.0 | 0.0 | 0.0 | |
| C1 | C2 | C3 | C4 | C5 | C6 | C7 | C8 | C9 | C10 | C11 | C12 | C13 | C14 | C15 | C16 |
| 0.0 | 0.0 | 0.0 | 0.0 | 0.0 | 0.0 | 0.0 | 0.0 | 0.0 | 0.0 | 0.0 | 0.0 | 0.0 | 0.0 | 0.0 | 0.0 |

| TM30 | | | |
|---------|----------------|--------|-----|
| Hue Bin | R _f | Chroma | Hue |
| 1 | 0 | 0% | 0% |
| 2 | 0 | 0% | 0% |
| 3 | 0 | 0% | 0% |
| 4 | 0 | 0% | 0% |
| 5 | 0 | 0% | 0% |
| 6 | 0 | 0% | 0% |
| 7 | 0 | 0% | 0% |
| 8 | 0 | 0% | 0% |
| 9 | 0 | 0% | 0% |
| 10 | 0 | 0% | 0% |
| 11 | 0 | 0% | 0% |
| 12 | 0 | 0% | 0% |
| 13 | 0 | 0% | 0% |
| 14 | 0 | 0% | 0% |
| 15 | 0 | 0% | 0% |
| 16 | 0 | 0% | 0% |

BLUE



CRI: 0.0
CRI R9: 0.0
TM30 Rf: 0.0
TM30 Rg: 0.0
CQS: 0.0
X: 0.140
Y: 0.078
U: 0.153
V: 0.128
Δuv: n/a

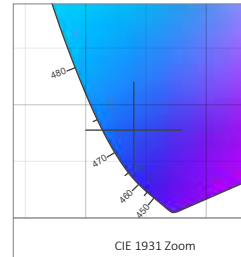
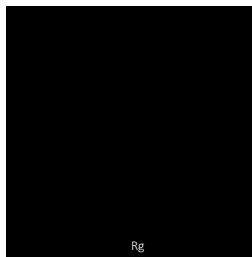
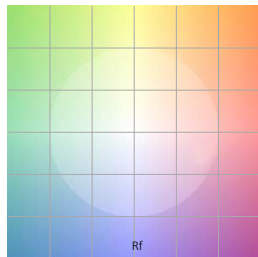

| R1 | R2 | R3 | R4 | R5 | R6 | R7 | R8 | R9 | R10 | R11 | R12 | R13 | R14 | R15 | |
|-----|-----|-----|-----|-----|-----|-----|-----|-----|-----|-----|-----|-----|-----|-----|-----|
| 0.0 | 0.0 | 0.0 | 0.0 | 0.0 | 0.0 | 0.0 | 0.0 | 0.0 | 0.0 | 0.0 | 0.0 | 0.0 | 0.0 | 0.0 | |
| Q1 | Q2 | Q3 | Q4 | Q5 | Q6 | Q7 | Q8 | Q9 | Q10 | Q11 | Q12 | Q13 | Q14 | Q15 | |
| 0.0 | 0.0 | 0.0 | 0.0 | 0.0 | 0.0 | 0.0 | 0.0 | 0.0 | 0.0 | 0.0 | 0.0 | 0.0 | 0.0 | 0.0 | |
| C1 | C2 | C3 | C4 | C5 | C6 | C7 | C8 | C9 | C10 | C11 | C12 | C13 | C14 | C15 | C16 |
| 0.0 | 0.0 | 0.0 | 0.0 | 0.0 | 0.0 | 0.0 | 0.0 | 0.0 | 0.0 | 0.0 | 0.0 | 0.0 | 0.0 | 0.0 | 0.0 |

| TM30 | | | |
|---------|----------------|--------|-----|
| Hue Bin | R _f | Chroma | Hue |
| 1 | 0 | 0% | 0% |
| 2 | 0 | 0% | 0% |
| 3 | 0 | 0% | 0% |
| 4 | 0 | 0% | 0% |
| 5 | 0 | 0% | 0% |
| 6 | 0 | 0% | 0% |
| 7 | 0 | 0% | 0% |
| 8 | 0 | 0% | 0% |
| 9 | 0 | 0% | 0% |
| 10 | 0 | 0% | 0% |
| 11 | 0 | 0% | 0% |
| 12 | 0 | 0% | 0% |
| 13 | 0 | 0% | 0% |
| 14 | 0 | 0% | 0% |
| 15 | 0 | 0% | 0% |
| 16 | 0 | 0% | 0% |

NOTES:

- CRI R values, only R1-R8 are used to calculate RA CRI values
- TM30 C values, 16 binned values out of total of 99 C values
- CQS Q values
- Data subject to change, all data has +/- 5% tolerance



FLEX SERIES IP67

COMPATIBLE EXTRUSIONS

iQA-FMZ-NONL: Non-Self-locking aluminum profile

Technical drawing of the iQA-FMZ-NONL aluminum profile. It includes three views: a side view showing a length of 7.85" and a screw hole diameter of 0.27" with a depth of 0.72"; a bottom view showing a length of 7.85" and a total length of 19.75"; and a Flex LED view showing a length of 4" and a screw hole diameter of 0.27" with a depth of 0.72". Dimensions for the profile are: 0.52" top flange, 0.78" total height, 0.86" bottom flange, 0.48" top flange thickness, 0.32" bottom flange thickness, and 0.54" bottom flange width.

| | |
|------------------|---------------------------|
| Length | : 1.5, 19.75, 39.5, 79 in |
| Dimension | : 0.54 x 0.86 x 0.52 in |
| Material | : Anodized Aluminum |
| Fits | : Flex Meza, Flex Round |
| Screws | : 0.72 x 0.27 in |

iQA-FMZ-SELF: Self-locking aluminum profile (Used with clip)

Technical drawing of the iQA-FMZ-SELF aluminum profile. It includes a side view showing a length of 39.5" and a screw hole diameter of 0.27" with a depth of 0.72". Dimensions for the profile are: 0.67" top flange, 0.82" total height, 0.93" bottom flange, 0.54" top flange thickness, 0.41" bottom flange thickness, and 0.65" bottom flange width. A 3D perspective view shows the profile with a clip attached.

| | |
|------------------|---------------------------|
| Length | : 1.5, 19.75, 39.5, 79 in |
| Dimension | : 0.65 x 0.93 x 0.67 in |
| Material | : Anodized Aluminum |
| Fits | : Flex Meza, Flex Round |
| Screws | : 0.72 x 0.27 in |



FLEX SERIES IP67

TYPES OF CONNECTOR

INJECTION-MOLDED CONNECTOR

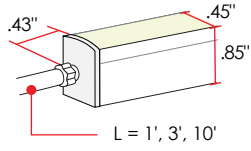

FMZ - IMFC -
FRONT L = 1', 3', 10'

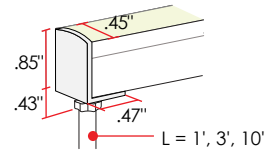

FMZ - IMBC -
BACK L = 1', 3', 10'

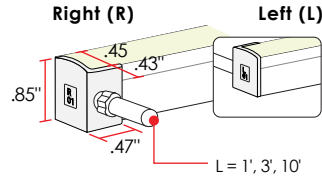

FMZ - IMSC - -
SIDE L or R L = 1', 3', 10'

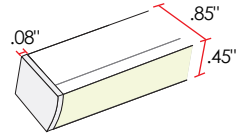

FMZ - IMEC
END CAP

SNAP CONNECTOR

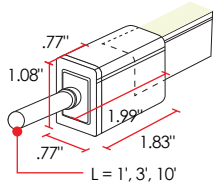

FMZ - SNFC -
FRONT L = 1', 3', 10'

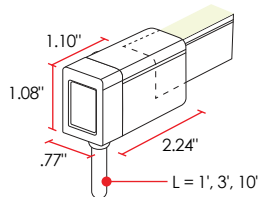

FMZ - SNBC -
BACK L = 1', 3', 10'

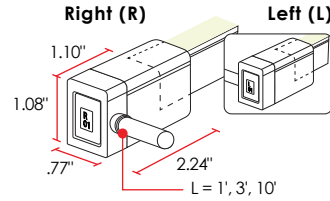

FMZ - SNSC - -
SIDE L or R L = 1', 3', 10'

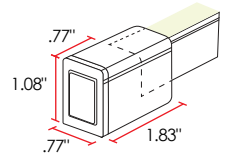

FMZ - SNEC
END CAP

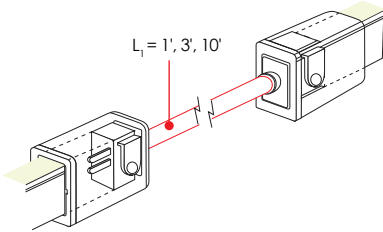

FMZ - SNJC -
JUMPER L = 1', 3', 10'



FLEX SERIES IP67
FLEX MEZA
 AMBER: WET RATED



The FLEX Series is the ideal LED for architectural spaces where the light will be in direct view. As the name implies, these LED lights are flexible and can be easily molded into different curvatures. The enclosure and the lens allow for a perfect monochromatic light source with no hot spots. All of Q-Tran's FLEX Series lights are made with high quality SMD LED chips, are UV and flame resistant, and are extremely energy efficient. Perfect replacement for glass Neon such as indoor, outdoor, signage & architecture. The amber color is turtle friendly for an eco-friendly option when designing a beach-front property

| | | | | | | | | |
|-------------|---|-----------|---|-------------|---|--------------|---|--------|
| iQ67 | - | AB | - | FMZ | - | 3.3 | - | |
| iQ series | | Color | | Flex series | | Watts Per FT | | Length |

iQ67-AB-FMZ-3.3

Max Run / Reel Length: 30ft | Color : Amber (AB)
 Voltage: 24VDC | Watts Per Ft: 3.3 | FMZ= Flex Meza
 Lumens per foot: 51

STANDARD DIMENSION

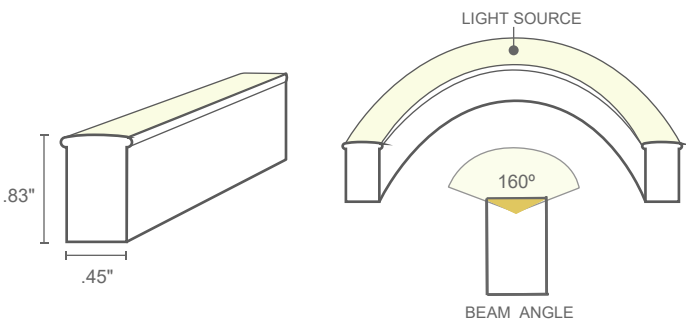

COMPATIBLE EXTRUSIONS

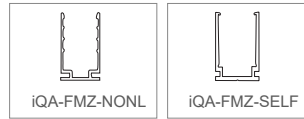

FEATURES

- IK08 rated
- High quality SMD LED chip
- Ambient temperature: -4°F ~ +113°F
- UV & Flame resistant construction
- Uniform & Even light source w/no LED "hotspots"
- 4.72" min. bending diameter
- Wave length : 585 - 595nm
- Run lengths up to 60 feet*

*For runs greater than 30 feet, 2 independent 100W drivers are required. One powering and wired to each end.

- Environmentally friendly & energy efficient
- UL 2108 – Low Voltage Lighting Systems
- UL 1598 – Luminaires
- 2 year warranty

NOTE: The warranty is only valid if compatible power supplies are used.

COMPATIBLE POWER SUPPLIES

Interior Applications

- Q6M-DC+CAP
- QTM-eLED, QTM-DC+CAP
- iQ-PH

Exterior Applications

- QOM-eLED, QOM-DC+CAP
- Q-SET-eLED
- iQ-PH

CUTTING INSTRUCTIONS:

This flex light can be cut on the dotted line mapped on the unit at every 6.56".



2019 0606 - V01

| PROJECT NAME | DATE | COMPANY | TYPE | NOTE |
|--------------|------|---------|------|------|
| | | | | |



FLEX SERIES IP67 COLOR DATA

AMBER

1910 K

- CRI:** -16.8
- CRI R9:** -394.4
- TM30 Rf:** 6.8
- TM30 Rg:** 36.0
- CQS:** 11.9
- X:** 0.524
- Y:** 0.395
- U:** 0.313
- V:** 0.354
- Auv:** -0.0056

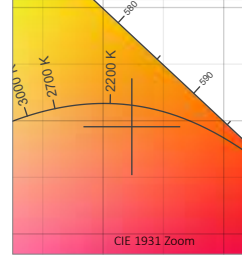
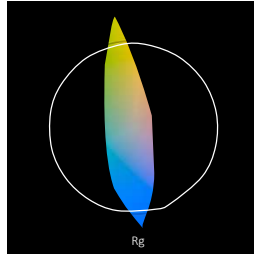
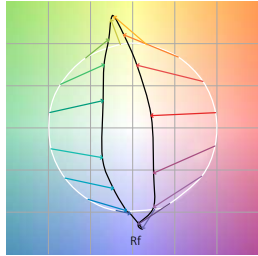

| R1 | R2 | R3 | R4 | R5 | R6 | R7 | R8 | R9 | R10 | R11 | R12 | R13 | R14 | R15 | |
|-------|------|------|-------|-------|------|------|--------|--------|------|-------|------|------|------|-------|-----|
| -31.7 | 58.1 | 14.2 | -59.6 | -29.3 | 51.8 | -8.9 | -129.2 | -394.4 | 41.9 | -80.6 | 28.2 | -9.8 | 43.5 | -64.1 | |
| Q1 | Q2 | Q3 | Q4 | Q5 | Q6 | Q7 | Q8 | Q9 | Q10 | Q11 | Q12 | Q13 | Q14 | Q15 | |
| 2.7 | 70.7 | 54.4 | 21.3 | 17.4 | 10.2 | 5.3 | 17.4 | 49.3 | 62.1 | 38.3 | 13.0 | 3.8 | 0.0 | 0.2 | |
| C1 | C2 | C3 | C4 | C5 | C6 | C7 | C8 | C9 | C10 | C11 | C12 | C13 | C14 | C15 | C16 |
| 0.0 | 0.0 | 0.2 | 26.4 | 68.9 | 51.2 | 11.5 | 7.4 | 0.7 | 3.8 | 16.6 | 51.7 | 64.1 | 46.9 | 7.0 | 0.6 |

| TM30 | | | |
|---------|----------------|--------|------|
| Hue Bin | R _f | Chroma | Hue |
| 1 | 0 | -76% | 11% |
| 2 | 0 | -54% | 60% |
| 3 | 0 | -14% | 68% |
| 4 | 26 | 25% | 45% |
| 5 | 69 | 31% | 5% |
| 6 | 51 | 3% | -35% |
| 7 | 12 | -30% | -48% |
| 8 | 7 | -59% | -26% |
| 9 | 1 | -58% | 22% |
| 10 | 4 | -41% | 42% |
| 11 | 17 | -14% | 45% |
| 12 | 52 | 0% | 17% |
| 13 | 64 | 20% | -19% |
| 14 | 47 | 0% | -44% |
| 15 | 7 | -27% | -62% |
| 16 | 1 | -65% | -46% |

NOTES:

- CRI R values, only R1-R8 are used to calculate RA CRI values
- TM30 C values, 16 binned values out of total of 99 C values
- CQS Q values
- Data subject to change, all data has +/- 5% tolerance



FLEX SERIES IP67

COMPATIBLE EXTRUSIONS

iQA-FMZ-NONL: Non-Self-locking aluminum profile

Technical drawing of the iQA-FMZ-NONL aluminum profile. It includes three views: Side view, Bottom view, and Flex LED view. The side view shows a cross-section with dimensions: 0.52" (top flange), 0.78" (total height), 0.86" (bottom flange), 0.48" (inner width), 0.32" (inner depth), and 0.54" (bottom flange width). A screw is shown with dimensions 0.27" (width) and 0.72" (height). The bottom view shows a length of 7.85" between two mounting holes and a total length of 19.75". The Flex LED view shows a 4" section with a screw hole and a Q-Tran LED logo.

| | |
|------------------|---------------------------|
| Length | : 1.5, 19.75, 39.5, 79 in |
| Dimension | : 0.54 x 0.86 x 0.52 in |
| Material | : Anodized Aluminum |
| Fits | : Flex Meza, Flex Round |
| Screws | : 0.72 x 0.27 in |

iQA-FMZ-SELF: Self-locking aluminum profile (Used with clip)

Technical drawing of the iQA-FMZ-SELF aluminum profile. It includes a cross-section view and an assembly view. The cross-section shows dimensions: 0.67" (top flange), 0.82" (total height), 0.93" (bottom flange), 0.54" (inner width), 0.41" (inner depth), and 0.65" (bottom flange width). The assembly view shows the profile with a clip and a 39.5" section. A 3D perspective view of the profile with a clip is also shown.

| | |
|------------------|---------------------------|
| Length | : 1.5, 19.75, 39.5, 79 in |
| Dimension | : 0.65 x 0.93 x 0.67 in |
| Material | : Anodized Aluminum |
| Fits | : Flex Meza, Flex Round |
| Screws | : 0.72 x 0.27 in |



FLEX SERIES IP67

TYPES OF CONNECTOR

INJECTION-MOLDED CONNECTOR

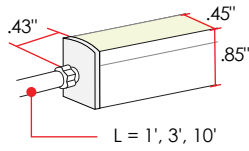

FMZ - IMFC - AB -
FRONT L = 1', 3', 10'

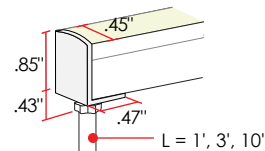

FMZ - IMBC - AB -
BACK L = 1', 3', 10'

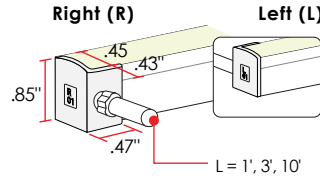

FMZ - IMSC - AB - -
SIDE L or R L = 1', 3', 10'

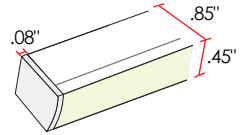

FMZ - IMEC
END CAP

SNAP CONNECTOR

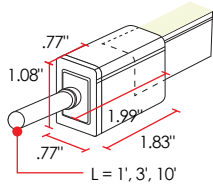

FMZ - SNFC - AB -
FRONT L = 1', 3', 10'

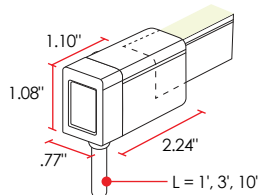

FMZ - SNBC - AB -
BACK L = 1', 3', 10'

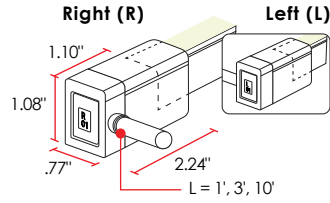

FMZ - SNSC - AB - -
SIDE L or R L = 1', 3', 10'

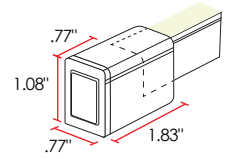

FMZ - SNEC
END CAP

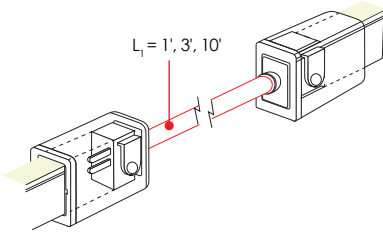

FMZ - SNJC - AB -
JUMPER L = 1', 3', 10'