

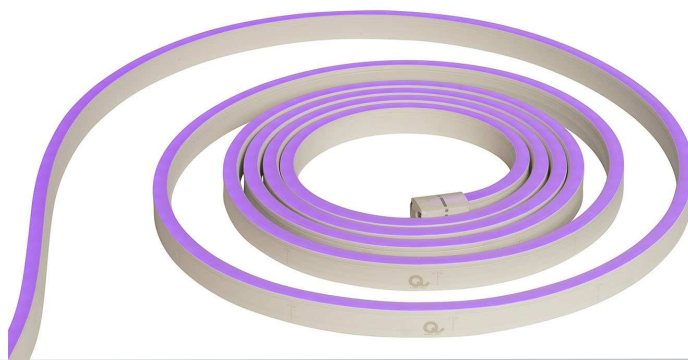

FLEX SERIES IP67
FLEX MEZA
 MULTI-COLOR:
 WET RATED



The FLEX Series is the ideal LED for architectural spaces where the light will be in direct view. As the name implies, these LED lights are flexible and can be easily molded into different curvatures. The enclosure and the lens allow for a perfect monochromatic light source with no hot spots. All of Q-Tran's FLEX Series lights are made with high quality SMD LED chips, are UV and flame resistant, and are extremely energy efficient. The FLEX Meza Multicolor (MC) is color changing and can be controlled by a Q-Tran supplied DMX controller or a third party controller may be used.

iQ67	-	MC	-	FMZ	-	3.3	-	
iQ series		Color		Flex series		Watts Per FT		Length

iQ67-MC-FMZ-3.3

Max Run / Reel Length: 30ft | Color : RGB (MC)
 Voltage: 24VDC | Watts Per Ft: 3.3 | FMZ= Flex Meza
 Lumens per foot: 100

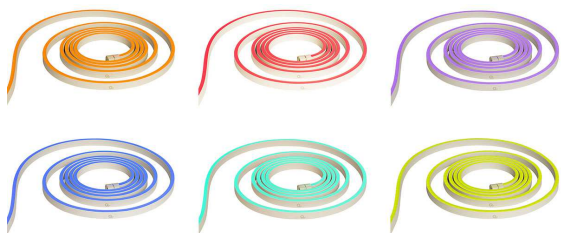

STANDARD DIMENSION

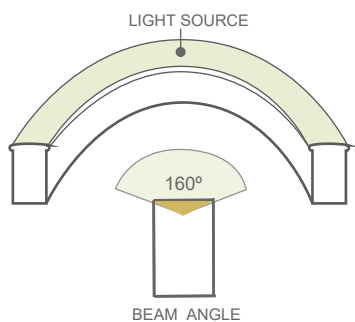
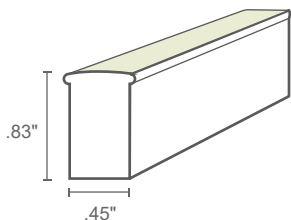

COMPATIBLE EXTRUSIONS

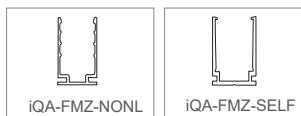

FEATURES

- IK08 rated
- High quality SMD LED chip
- Ambient temperature: -4°F ~ +113°F
- UV & Flame resistant construction
- Uniform & Even light source w/no LED "hotspots"
- 4.72" min. bending diameter
- Run lengths up to 60 feet*
- *For runs greater than 30 feet, 2 independent 100W drivers are required. One powering and wired to each end.
- Environmentally friendly & energy efficient
- UL 2108 – Low Voltage Lighting Systems
- UL 1598 – Luminaires
- 2 year warranty

NOTE: The warranty is only valid if compatible power supplies are used.

COMPATIBLE POWER SUPPLIES

Interior Applications

- QTM-eLED+DMX
- QTM-DRIVE

Exterior Applications

- QOM-eLED+DMX
- QOM-DRIVE

CUTTING INSTRUCTIONS:

This flex light can be cut on the dotted line mapped on the unit at every 3.94".



2019 0606 - V01

PROJECT NAME	DATE	COMPANY	TYPE	NOTE



FLEX SERIES IP67

COMPATIBLE EXTRUSIONS

iQA-FMZ-NONL: Non-Self-locking aluminum profile

Side view
 Dimensions: 0.27", 0.72", 0.52", 0.78", 0.86", 0.48", 0.32", 0.54", 7.85"

Bottom view
 Dimensions: 7.85", 19.75"

Flex LED
 Dimensions: 4"

Length : 1.5, 19.75, 39.5, 79 in
Dimension : 0.54 x 0.86 x 0.52 in
Material : Anodized Aluminum
Fits : Flex Meza, Flex Round
Screws : 0.72 x 0.27 in

iQA-FMZ-SELF: Self-locking aluminum profile (Used with clip)

Side view
 Dimensions: 0.67", 0.82", 0.93", 0.54", 0.41", 0.65"

Assembly view
 Dimensions: 0.78", 0.67", 0.49", 0.55", 39.5"

Length : 1.5, 19.75, 39.5, 79 in
Dimension : 0.65 x 0.93 x 0.67 in
Material : Anodized Aluminum
Fits : Flex Meza, Flex Round
Screws : 0.72 x 0.27 in



FLEX SERIES IP67

TYPES OF CONNECTOR

INJECTION-MOLDED CONNECTOR

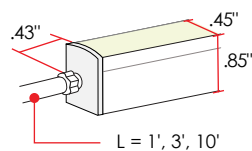

FMZ - IMFC - MC -
FRONT L = 1', 3', 10'

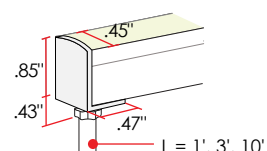

FMZ - IMBC - MC -
BACK L = 1', 3', 10'

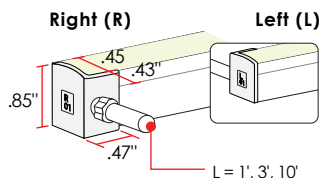

FMZ - IMSC - MC - -
SIDE L or R L = 1', 3', 10'

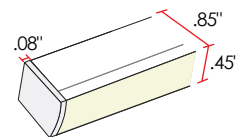

FMZ - IMEC
END CAP

SNAP CONNECTOR

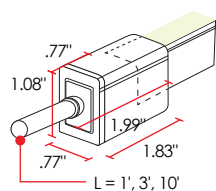

FMZ - SNFC - MC -
FRONT L = 1', 3', 10'

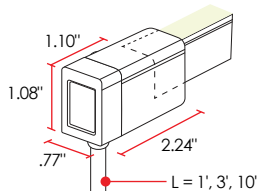

FMZ - SNBC - MC -
BACK L = 1', 3', 10'

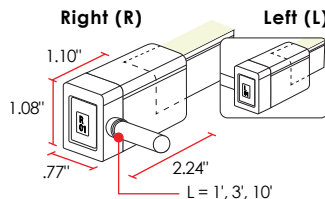

FMZ - SNSC - MC - -
SIDE L or R L = 1', 3', 10'

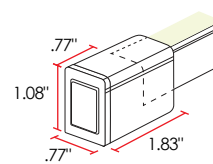

FMZ - SNEC
END CAP

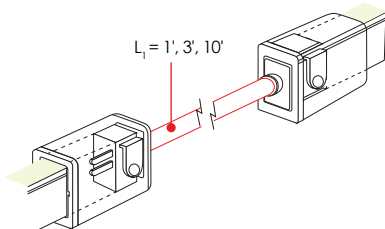

FMZ - SNJC - MC -
JUMPER L = 1', 3', 10'