

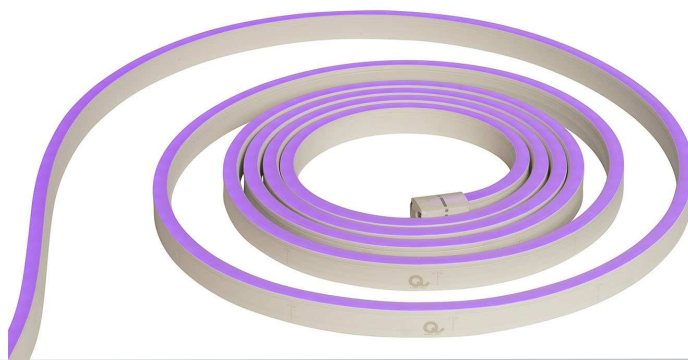

FLEX SERIES IP67  
**FLEX MEZA**  
 MULTI-COLOR:  
 WET RATED



The FLEX Series is the ideal LED for architectural spaces where the light will be in direct view. As the name implies, these LED lights are flexible and can be easily molded into different curvatures. The enclosure and the lens allow for a perfect monochromatic light source with no hot spots. All of Q-Tran's FLEX Series lights are made with high quality SMD LED chips, are UV and flame resistant, and are extremely energy efficient. The FLEX Meza Multicolor (MC) is color changing and can be controlled by a Q-Tran supplied DMX controller or a third party controller may be used.

<b>iQ67</b>	-	<b>MC</b>	-	<b>FMZ</b>	-	<b>3.3</b>	-	
iQ series		Color		Flex series		Watts Per FT		Length

**iQ67-MC-FMZ-3.3**

Max Run / Reel Length: 30ft | Color : RGB (MC)  
 Voltage: 24VDC | Watts Per Ft: 3.3 | FMZ= Flex Meza  
 Lumens per foot: 100

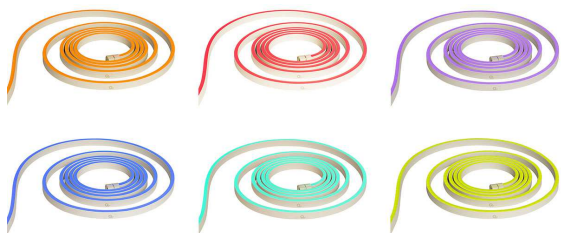

**STANDARD DIMENSION**

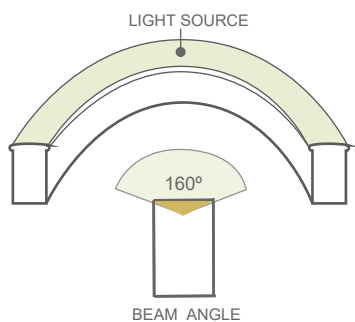
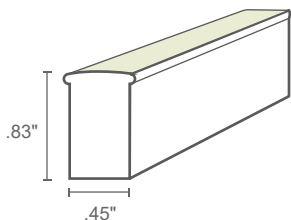

**COMPATIBLE EXTRUSIONS**

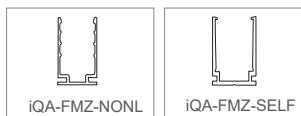

**FEATURES**

- IK08 rated
- High quality SMD LED chip
- Ambient temperature: -4°F ~ +113°F
- UV & Flame resistant construction
- Uniform & Even light source w/no LED "hotspots"
- 4.72" min. bending diameter
- Run lengths up to 60 feet\*
- \*For runs greater than 30 feet, 2 independent 100W drivers are required. One powering and wired to each end.
- Environmentally friendly & energy efficient
- UL 2108 – Low Voltage Lighting Systems
- UL 1598 – Luminaires
- 2 year warranty

**NOTE:** The warranty is only valid if compatible power supplies are used.

**COMPATIBLE POWER SUPPLIES**

**Interior Applications**

- QTM-eLED+DMX
- QTM-DRIVE

**Exterior Applications**

- QOM-eLED+DMX
- QOM-DRIVE

**CUTTING INSTRUCTIONS:**

This flex light can be cut on the dotted line mapped on the unit at every 3.94".



2019 0606 - V01

PROJECT NAME	DATE	COMPANY	TYPE	NOTE



FLEX SERIES IP67

# COMPATIBLE EXTRUSIONS

## iQA-FMZ-NONL: Non-Self-locking aluminum profile

Technical drawing of the iQA-FMZ-NONL aluminum profile. It includes three views: a side view showing a length of 7.85" and a screw hole diameter of 0.72" with a depth of 0.27"; a bottom view showing a length of 7.85" and a total length of 19.75"; and a Flex LED view showing a length of 4" and a screw hole diameter of 0.72" with a depth of 0.27". Dimensions for the profile are: 0.52" top width, 0.78" top height, 0.86" total height, 0.48" bottom width, 0.32" bottom height, and 0.54" bottom width.

<b>Length</b>	: 1.5, 19.75, 39.5, 79 in
<b>Dimension</b>	: 0.54 x 0.86 x 0.52 in
<b>Material</b>	: Anodized Aluminum
<b>Fits</b>	: Flex Meza, Flex Round
<b>Screws</b>	: 0.72 x 0.27 in

## iQA-FMZ-SELF: Self-locking aluminum profile (Used with clip)

Technical drawing of the iQA-FMZ-SELF aluminum profile. It includes a side view showing a length of 39.5" and a screw hole diameter of 0.72" with a depth of 0.27". Dimensions for the profile are: 0.67" top width, 0.82" top height, 0.93" total height, 0.54" bottom width, 0.41" bottom height, and 0.65" bottom width.

<b>Length</b>	: 1.5, 19.75, 39.5, 79 in
<b>Dimension</b>	: 0.65 x 0.93 x 0.67 in
<b>Material</b>	: Anodized Aluminum
<b>Fits</b>	: Flex Meza, Flex Round
<b>Screws</b>	: 0.72 x 0.27 in



FLEX SERIES IP67

# TYPES OF CONNECTOR

## INJECTION-MOLDED CONNECTOR

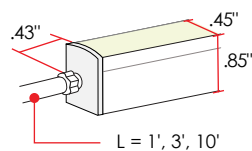

**FMZ - IMFC - MC** -   
FRONT L = 1', 3', 10'

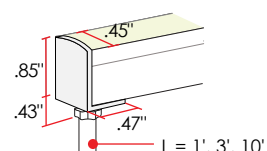

**FMZ - IMBC - MC** -   
BACK L = 1', 3', 10'

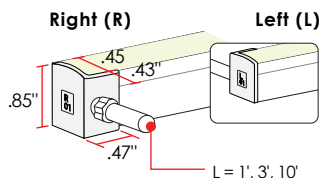

**FMZ - IMSC - MC** -  -   
SIDE L or R L = 1', 3', 10'

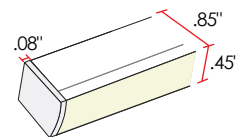

**FMZ - IMEC**  
END CAP

## SNAP CONNECTOR

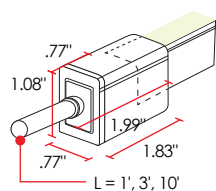

**FMZ - SNFC - MC** -   
FRONT L = 1', 3', 10'

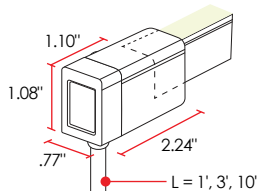

**FMZ - SNBC - MC** -   
BACK L = 1', 3', 10'

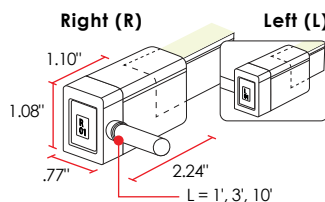

**FMZ - SNSC - MC** -  -   
SIDE L or R L = 1', 3', 10'

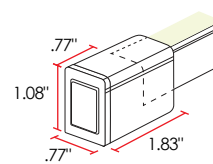

**FMZ - SNEC**  
END CAP

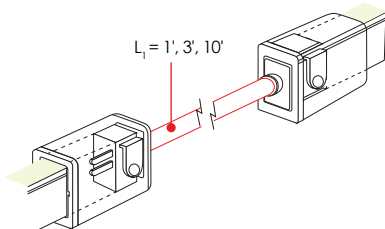

**FMZ - SNJC - MC** -   
JUMPER L = 1', 3', 10'