



# iQ66 LED SUPERBEND LARGE (SBDL) MULTI-COLOR

A versatile, flexible LED power strip that is bendable in a variety of different directions. Great light source for indoor and covered outdoor applications with a rating of IP66 which is water resistant to protect against the elements. The LED is color changing and can be controlled by a Q-Tran supplied DMX controller or a third party controller may be used.

<b>iQ66</b>	-	<b>MC</b>	-	<b>SBDL</b>	-	<b>7.0</b>	-	
iQ Series		Color		Type		Watts Per FT		Length

## iQ66-MC-SBDL-7.0

Max Run / Reel Length: 13ft\* | Color: Multi-Color( MC )  
Voltage: 24VDC | Watts Per Ft: 7.0 | Lumens Per Ft (ALL): 170



\*Maximum length for one run of iQ66 Super Flex 7.0. Individual Power supply cut sheets will provide max distance/loads per power supply.

## FEATURES

- LED life time - 30,000 hours
- Minimum bending radius 5"
- Operating temperature: -4°F ~ +113°F
- Ingress protection rating IP66(Dot-Free)
- 3 year warranty

### ✂ CUTTING INSTRUCTIONS:

This flex light can be cut on the dotted line mapped on the unit at every 1.3"

Lead wire comes in 18" (18/2AWG)  
( See instructions for more details )



INWARD BENDING

OUTWARD BENDING

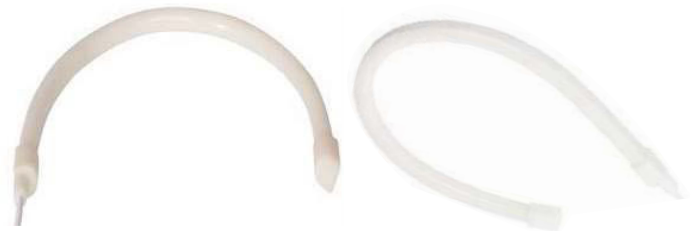

2019 0227 - V01

PROJECT NAME	DATE	COMPANY	TYPE	NOTE



# iQ66 LED SUPERBEND LARGE (SBDL) DIMENSIONS

## DIMENSIONS

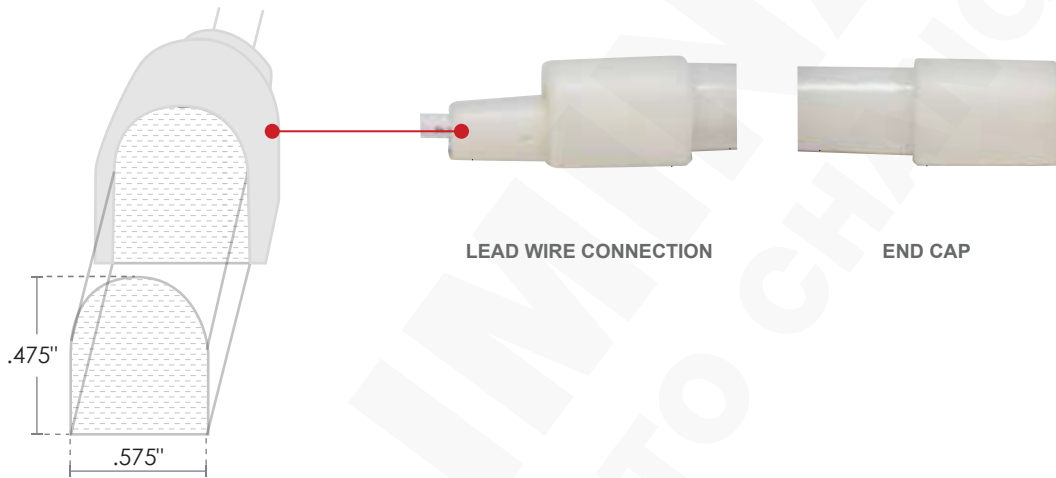
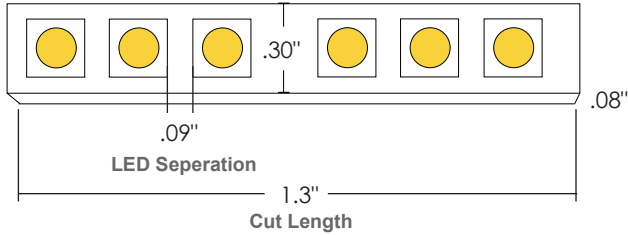

## MOUNTING CLIPS

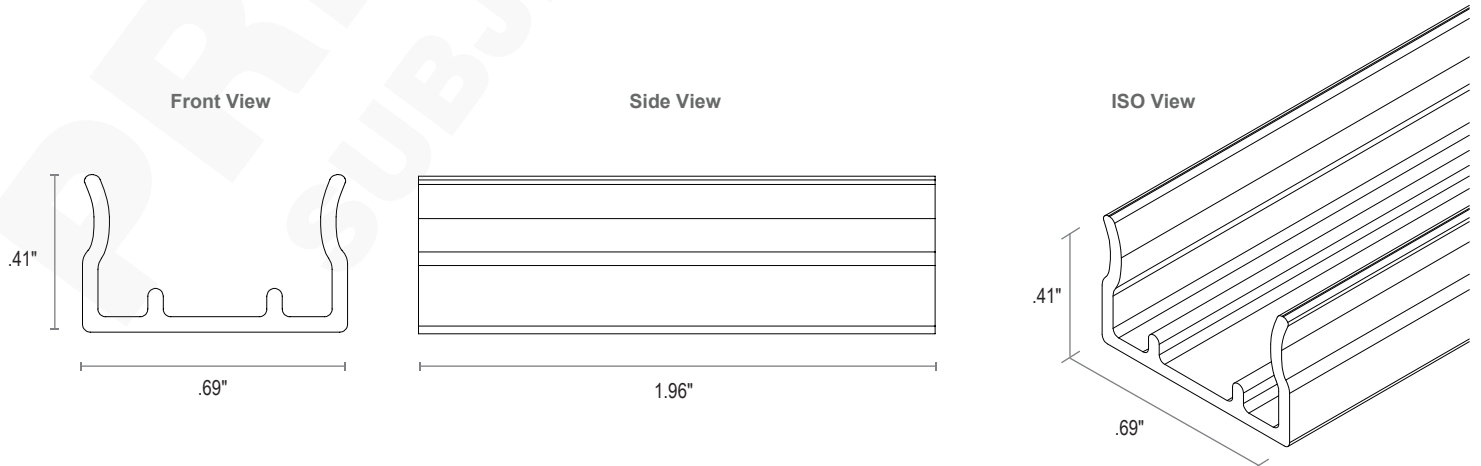



# iQ66 LED SUPERBEND LARGE (SBDL) COLOR DATA

## RED

0 K

**CRI:** 0.0  
**CRI R9:** 0.0  
**TM30 Rf:** 0.0  
**TM30 Rg:** 0.0  
**CQS:** 0.0  
**X:** 0.593  
**Y:** 0.283  
**U:** 0.455  
**V:** 0.326  
**Δuv:** n/a

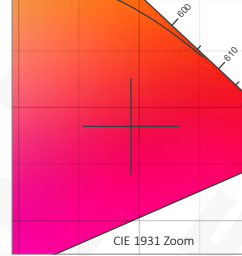
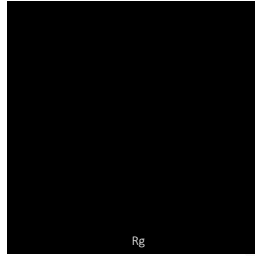
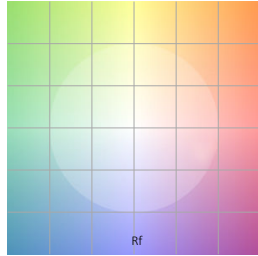

R1	R2	R3	R4	R5	R6	R7	R8	R9	R10	R11	R12	R13	R14	R15	
0.0	0.0	0.0	0.0	0.0	0.0	0.0	0.0	0.0	0.0	0.0	0.0	0.0	0.0	0.0	
Q1	Q2	Q3	Q4	Q5	Q6	Q7	Q8	Q9	Q10	Q11	Q12	Q13	Q14	Q15	
0.0	0.0	0.0	0.0	0.0	0.0	0.0	0.0	0.0	0.0	0.0	0.0	0.0	0.0	0.0	
C1	C2	C3	C4	C5	C6	C7	C8	C9	C10	C11	C12	C13	C14	C15	C16
0.0	0.0	0.0	0.0	0.0	0.0	0.0	0.0	0.0	0.0	0.0	0.0	0.0	0.0	0.0	0.0

TM30			
Hue Bin	R <sub>f</sub>	Chroma	Hue
1	0	0%	0%
2	0	0%	0%
3	0	0%	0%
4	0	0%	0%
5	0	0%	0%
6	0	0%	0%
7	0	0%	0%
8	0	0%	0%
9	0	0%	0%
10	0	0%	0%
11	0	0%	0%
12	0	0%	0%
13	0	0%	0%
14	0	0%	0%
15	0	0%	0%
16	0	0%	0%

## GREEN

0 K

**CRI:** 0.0  
**CRI R9:** 0.0  
**TM30 Rf:** 0.0  
**TM30 Rg:** 0.0  
**CQS:** 0.0  
**X:** 0.147  
**Y:** 0.676  
**U:** 0.055  
**V:** 0.375  
**Δuv:** n/a

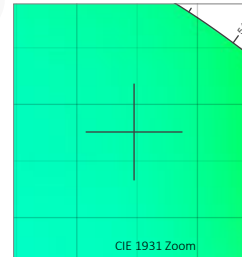
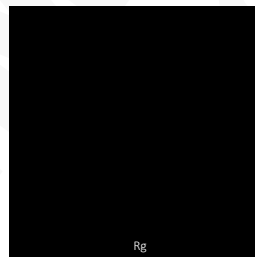
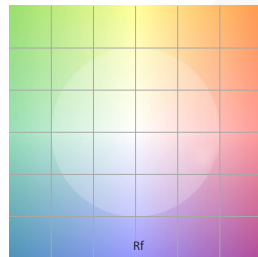

R1	R2	R3	R4	R5	R6	R7	R8	R9	R10	R11	R12	R13	R14	R15	
0.0	0.0	0.0	0.0	0.0	0.0	0.0	0.0	0.0	0.0	0.0	0.0	0.0	0.0	0.0	
Q1	Q2	Q3	Q4	Q5	Q6	Q7	Q8	Q9	Q10	Q11	Q12	Q13	Q14	Q15	
0.0	0.0	0.0	0.0	0.0	0.0	0.0	0.0	0.0	0.0	0.0	0.0	0.0	0.0	0.0	
C1	C2	C3	C4	C5	C6	C7	C8	C9	C10	C11	C12	C13	C14	C15	C16
0.0	0.0	0.0	0.0	0.0	0.0	0.0	0.0	0.0	0.0	0.0	0.0	0.0	0.0	0.0	0.0

TM30			
Hue Bin	R <sub>f</sub>	Chroma	Hue
1	0	0%	0%
2	0	0%	0%
3	0	0%	0%
4	0	0%	0%
5	0	0%	0%
6	0	0%	0%
7	0	0%	0%
8	0	0%	0%
9	0	0%	0%
10	0	0%	0%
11	0	0%	0%
12	0	0%	0%
13	0	0%	0%
14	0	0%	0%
15	0	0%	0%
16	0	0%	0%

**NOTES:**

- CRI R values, only R1-R8 are used to calculate RA CRI values
- TM30 C values, 16 binned values out of total of 99 C values
- CQS Q values
- Data subject to change, all data has +/- 5% tolerance



# iQ66 LED SUPERBEND LARGE (SBDL) COLOR DATA

## BLUE



**CRI:** 0.0  
**CRI R9:** 0.0  
**TM30 Rf:** 0.0  
**TM30 Rg:** 0.0  
**CQS:** 0.0  
**X:** 0.140  
**Y:** 0.070  
**U:** 0.158  
**V:** 0.117  
**Δuv:** n/a

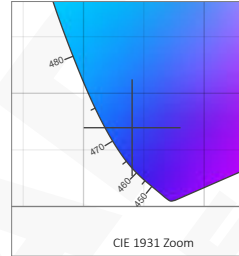
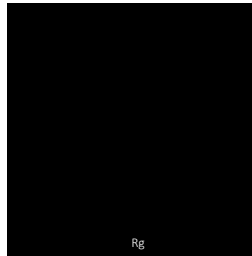
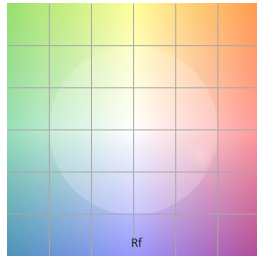

R1	R2	R3	R4	R5	R6	R7	R8	R9	R10	R11	R12	R13	R14	R15	
0.0	0.0	0.0	0.0	0.0	0.0	0.0	0.0	0.0	0.0	0.0	0.0	0.0	0.0	0.0	
Q1	Q2	Q3	Q4	Q5	Q6	Q7	Q8	Q9	Q10	Q11	Q12	Q13	Q14	Q15	
0.0	0.0	0.0	0.0	0.0	0.0	0.0	0.0	0.0	0.0	0.0	0.0	0.0	0.0	0.0	
C1	C2	C3	C4	C5	C6	C7	C8	C9	C10	C11	C12	C13	C14	C15	C16
0.0	0.0	0.0	0.0	0.0	0.0	0.0	0.0	0.0	0.0	0.0	0.0	0.0	0.0	0.0	0.0

TM30			
Hue Bin	R <sub>f</sub>	Chroma	Hue
1	0	0%	0%
2	0	0%	0%
3	0	0%	0%
4	0	0%	0%
5	0	0%	0%
6	0	0%	0%
7	0	0%	0%
8	0	0%	0%
9	0	0%	0%
10	0	0%	0%
11	0	0%	0%
12	0	0%	0%
13	0	0%	0%
14	0	0%	0%
15	0	0%	0%
16	0	0%	0%

## ALL



**CRI:** 0.0  
**CRI R9:** 0.0  
**TM30 Rf:** 0.0  
**TM30 Rg:** 0.0  
**CQS:** 0.0  
**X:** 0.204  
**Y:** 0.241  
**U:** 0.149  
**V:** 0.264  
**Δuv:** n/a

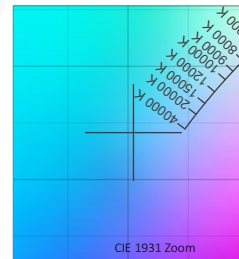
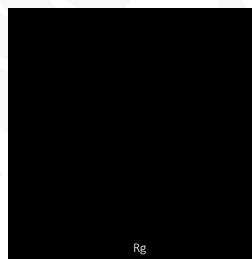
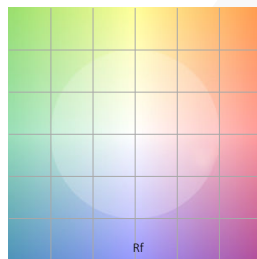

R1	R2	R3	R4	R5	R6	R7	R8	R9	R10	R11	R12	R13	R14	R15	
0.0	0.0	0.0	0.0	0.0	0.0	0.0	0.0	0.0	0.0	0.0	0.0	0.0	0.0	0.0	
Q1	Q2	Q3	Q4	Q5	Q6	Q7	Q8	Q9	Q10	Q11	Q12	Q13	Q14	Q15	
0.0	0.0	0.0	0.0	0.0	0.0	0.0	0.0	0.0	0.0	0.0	0.0	0.0	0.0	0.0	
C1	C2	C3	C4	C5	C6	C7	C8	C9	C10	C11	C12	C13	C14	C15	C16
0.0	0.0	0.0	0.0	0.0	0.0	0.0	0.0	0.0	0.0	0.0	0.0	0.0	0.0	0.0	0.0

TM30			
Hue Bin	R <sub>f</sub>	Chroma	Hue
1	0	0%	0%
2	0	0%	0%
3	0	0%	0%
4	0	0%	0%
5	0	0%	0%
6	0	0%	0%
7	0	0%	0%
8	0	0%	0%
9	0	0%	0%
10	0	0%	0%
11	0	0%	0%
12	0	0%	0%
13	0	0%	0%
14	0	0%	0%
15	0	0%	0%
16	0	0%	0%

**NOTES:**

- CRI R values, only R1-R8 are used to calculate RA CRI values
- TM30 C values, 16 binned values out of total of 99 C values
- CQS Q values
- Data subject to change, all data has +/- 5% tolerance



iQ66 LED SUPERBEND LARGE (SBDL)  
**POWER SUPPLIES**

**QTM-eLED+DMX** : for interior

**QOM-eLED+DMX** : for exterior

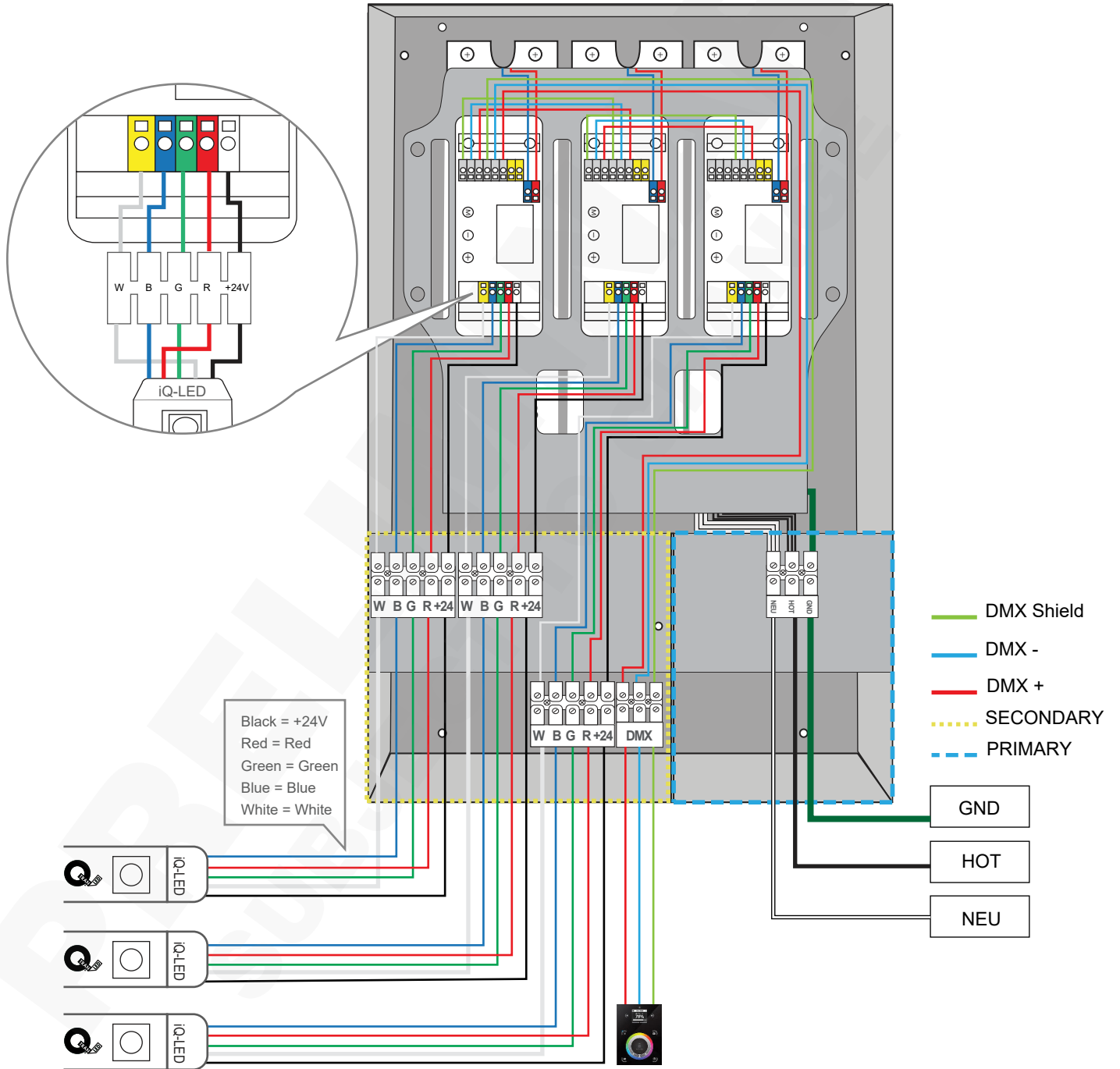



# iQ66 LED SUPERBEND LARGE (SBDL) POWER SUPPLIES

**QTM-DRIVE** : for interior

**QOM-DRIVE** : for exterior

