

LALO

EXTRUSIONS - ALUMINUM

Model: iQA

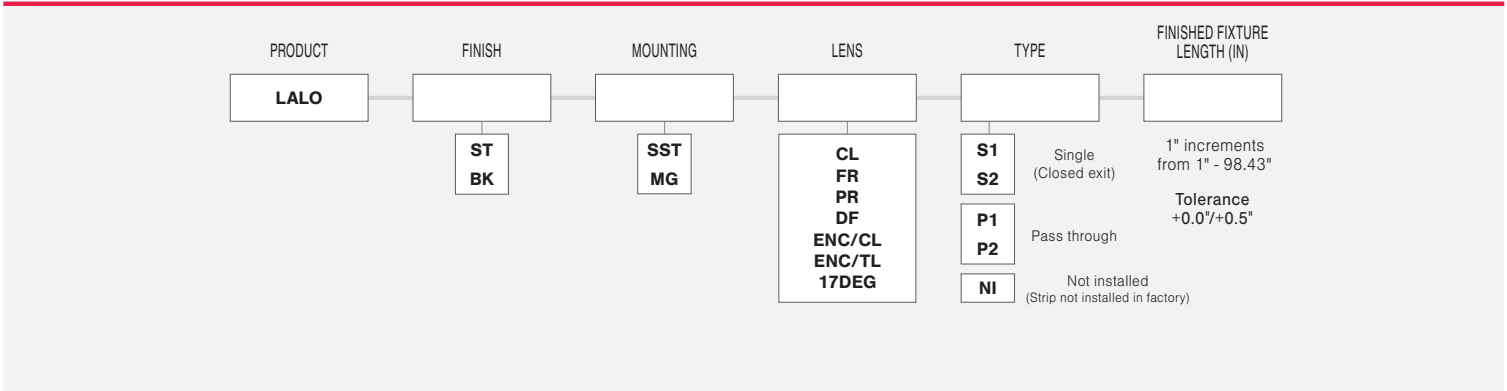

- NOTES:**
- UL Listed when assembled with STRIP LEDs at Q-Tran
 - NRTL Listed for install in Storage Areas with Clothing, NEC Field 410.2 and 410.16 when assembled as a fixture, with 4.0 w/ft or less, at Q-Tran facility (Not applicable for encapsulation)
 - Field modifications must comply with Q-Tran's installation methods otherwise warranty is null and void

FINISH

ST	BK
Satin	Black

MOUNTING NOTE: 2 clips provided for 4' or less; 4 clips provided for greater than 4'

SST	MG
Stainless Steel	Magnet clip

LENS with LED visibility

CL	FR	PR	DF	ENC/CL	ENC/TL	17DEG
Clear	Frosted	Polar	Diffused	Encapsulated in Clear	Encapsulated in Translucent	Optical

DIMENSIONS

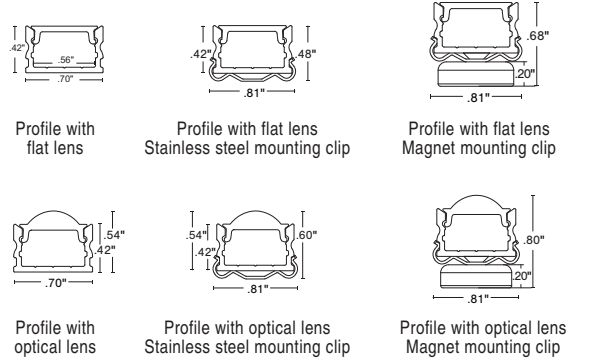

TYPE

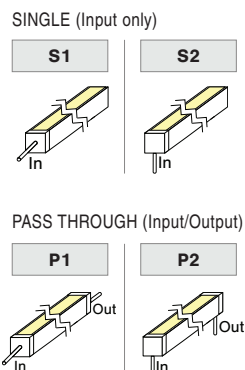

ORDER EXAMPLE

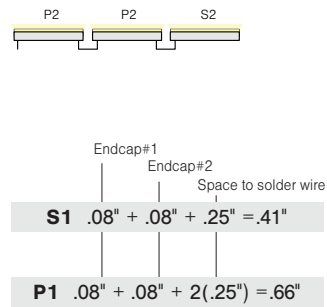

END CAPS

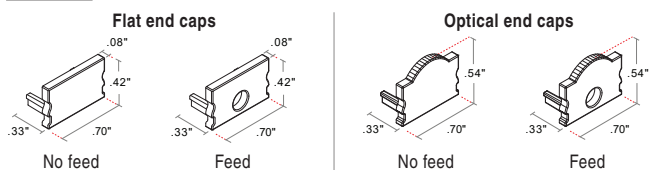

LENGTH (IN) : Add to nominal LED length for fixture length

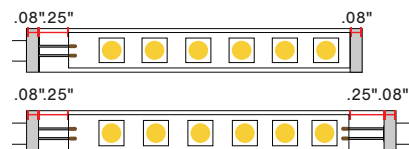

CUT OFF

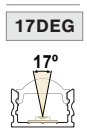

COMPATIBLE LEDs

STATIC WHITE (SW)				DYNAMIC WHITE (DW)				STATIC COLOR (SC)				RGB			RGBW			
DRY	DMP	WET	ENC	DRY	DMP	WET	ENC	DRY	DMP	WET	ENC	DRY	DMP	WET	DRY	DMP	WET	ENC
✓	✓	✓	✓	✓	✓	✓	✓	✓	✓	✓	✓	✓	✓	✓	✓	✓	✓	✓
✓	◆	◆	◆	✓	◆	◆	◆	✓	◆	◆	◆	✓	◆	◆	✓	◆	◆	◆

✓ = Compatible ✗ = NOT Compatible ◆ = NOT Compatible with 6.0 & 7.5 strips

PROJECT NAME	DATE	COMPANY	TYPE	NOTE